

Project Name / Proje Adı : Tuna Mobilya  
System / Sistem : AF68  
City / Şehir : Kınalı, Silivri, İstanbul - TÜRKİYE



ALCAS®



# AF68

Steel Covered Facade System  
Çelik Takviyeli Cephe Sistemi

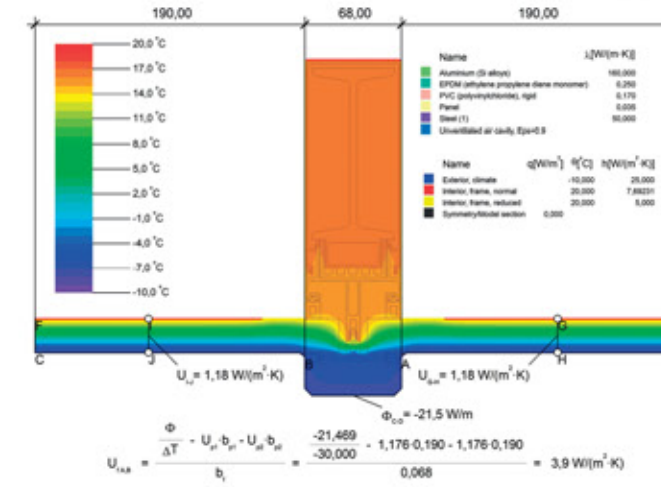

## Descriptions / Tanımlamalar

Brand / Marka		Profile type description / Profil tip tanımlamaları	
A	Brand <b>ALCAS®</b>	Marka <b>ALCAS®</b>	M Mullion Mulyon
F	System Type Facade	Sistem Tipi Cephe	T Transom Transom
50	Series Length	Seri Geniřliđi	V Vent Kanat
R	Profile Type	Profil Tipi	A Adapter Adaptör
01	Group Location	Gruptaki Yeri	C Cover Kapak

## Symbols / Semboller

	Corner block assembly with 45° cutting process 45° kesim işlemi köşe takozu ile birleştirme
	Milling process of merging with the vertical connection Kertme işlemi dik bağlantı ile birleştirme
	Cross-sectional aspect of strength Mukavemet kesit yönü

Yüksek plan akslarında kullanılmak üzere dizayn edilen çelik profil takviyeli kapaklı cephe sistemi **ALCAS®** AF68 serisi 68 mm genişliğinde olup 50'lik, 80'lik ve 147'lik alt kapak profillerine sahiptir.

AF50 serisinin bir çok profil ve aksesuarının ortak olarak kullanılabildiđi AF68 serisi showroomlar, havaalanları, otel lobileri gibi kat yüksekliđi olan bölgelerde esneme yapmaması, rüzgar, deprem gibi şartlarda cephelerin esnememesi ve kırılmaması için ideal bir cephe sistemidir.

**ALCAS®** AF68 series of steel profile reinforced covered Facade system, which is designed to be used at the high plan axis has a width of 68 mm and also has got lower cover profiles of 50, 80 and 147, AF68 series, in which a lot of profiles and accessories of AF50 series are used in common, is an ideal system in order that Facades do not bend and break under the conditions like wind, earthquake in the areas having storey height such as showrooms, airports and hotel lobbies.

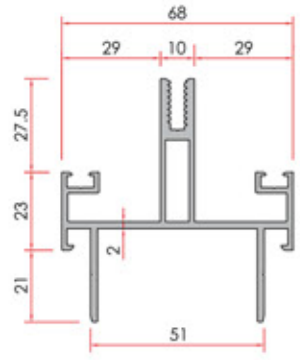

**Mullion**  
Mulyon

System Code	Profile No	Weight kg	
AF68 M 01	1071	1.488	
Jxx cm4	18.8	Jyy cm4	25.4

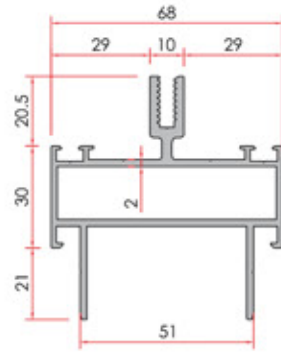

**Transom**  
Transom

System Code	Profile No	Weight kg	
AF68 T 01	1073	1.669	
Jxx cm4	18.6	Jyy cm4	29.6

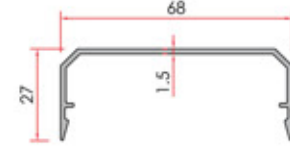

**Vertical Cover**  
Düsey Kapak

System Code	Profile No	Weight kg
AF68 C 01	1078	0.484

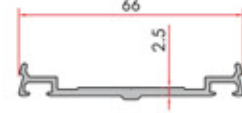

**Cover**  
Baskı Kapak

System Code	Profile No	Weight kg
AF68 C 02	1079	0.508

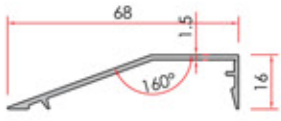

**Horizontal Cover**  
Yatay Kapak

System Code	Profile No	Weight kg
AF68 C 05	1080	0.369

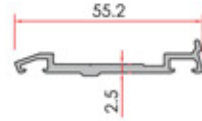

**Cover**  
Baskı Kapak

System Code	Profile No	Weight kg
AF68 C 06	1081	0.413



**Cover**  
Baskı Kapak

System Code	Profile No	Weight kg
AF68 C 08	1099	0.628

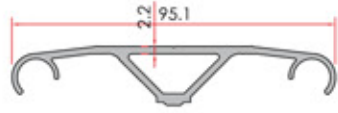

**Cover**  
Baskı Kapak

System Code	Profile No	Weight kg
AF68 C 10	1154	0.932



**Mulyon Angle Adapter Adjustment**  
Mulyon Açı Ayar Adaptörü

System Code	Profile No	Weight kg
AF68 A 02	1157	0.194



**Cover Angle Adapter Adjustment**  
Kapak Açı Ayar Adaptörü

System Code	Profile No	Weight kg
AF68 A 03	1158	0.137

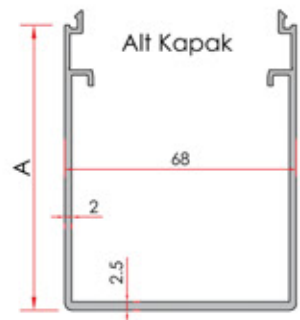

**Bottom Cover Profile**  
Alt Kapak Profili

A	System Code	Profile No	Weight kg/mt
50 mm	AF68 C 04	1077	0.995
87 mm	AF68 C 07	1076	1.485
147 mm	AF68 C 03	1075	2.453
240 mm	AF68 C 09	1195	4.008

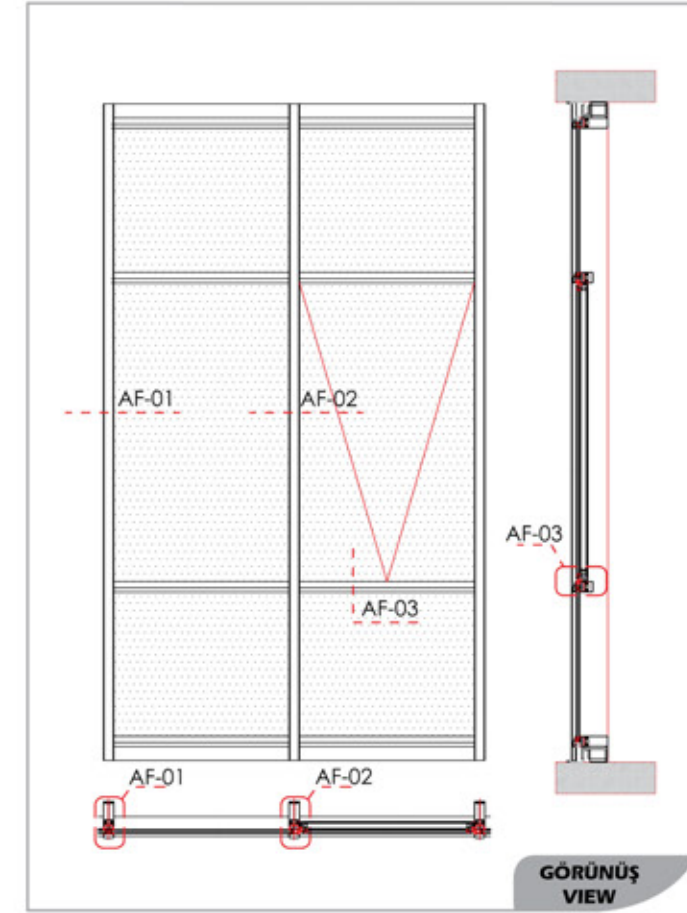

**GÖRÜNÜŞ**  
VIEW

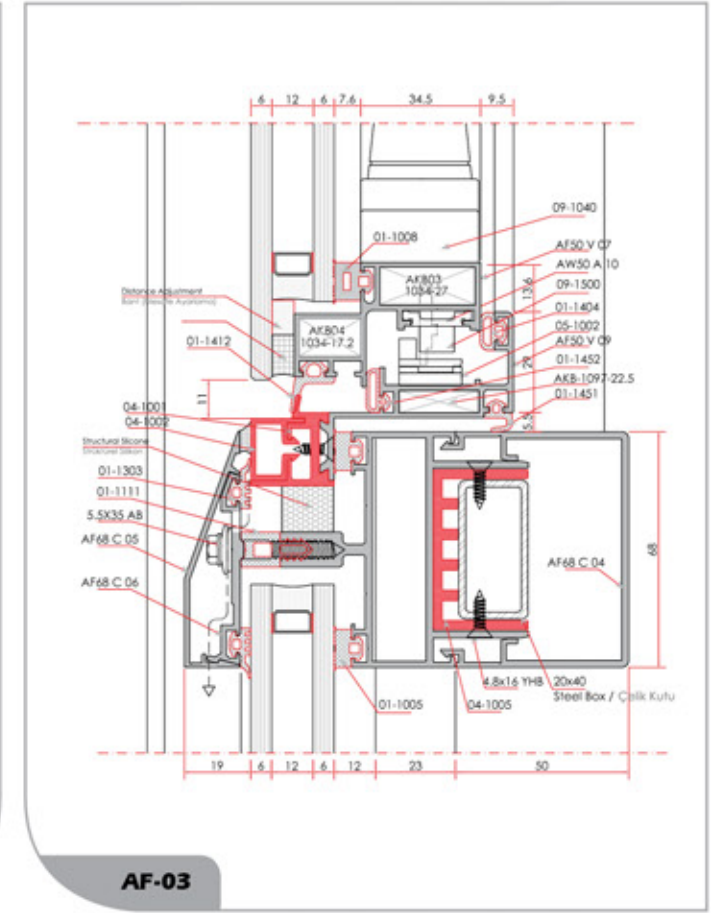

**AF-03**

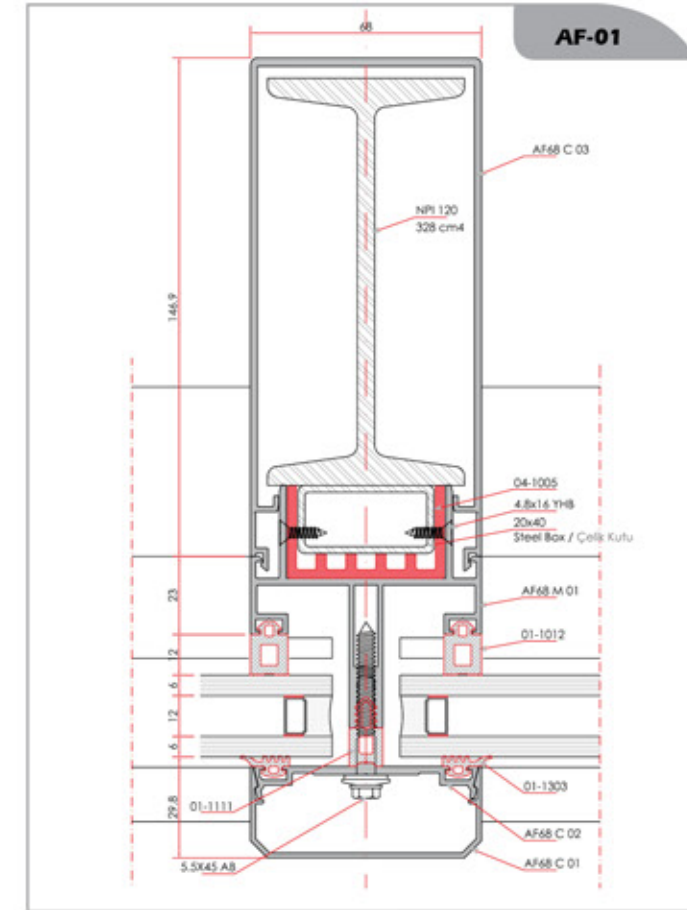

**AF-01**

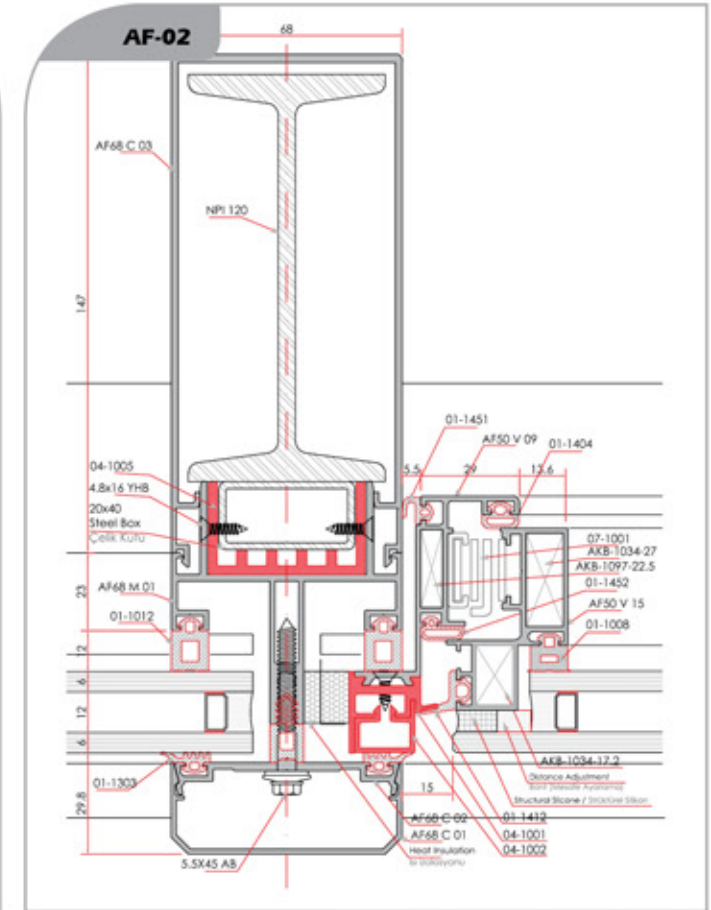

**AF-02**

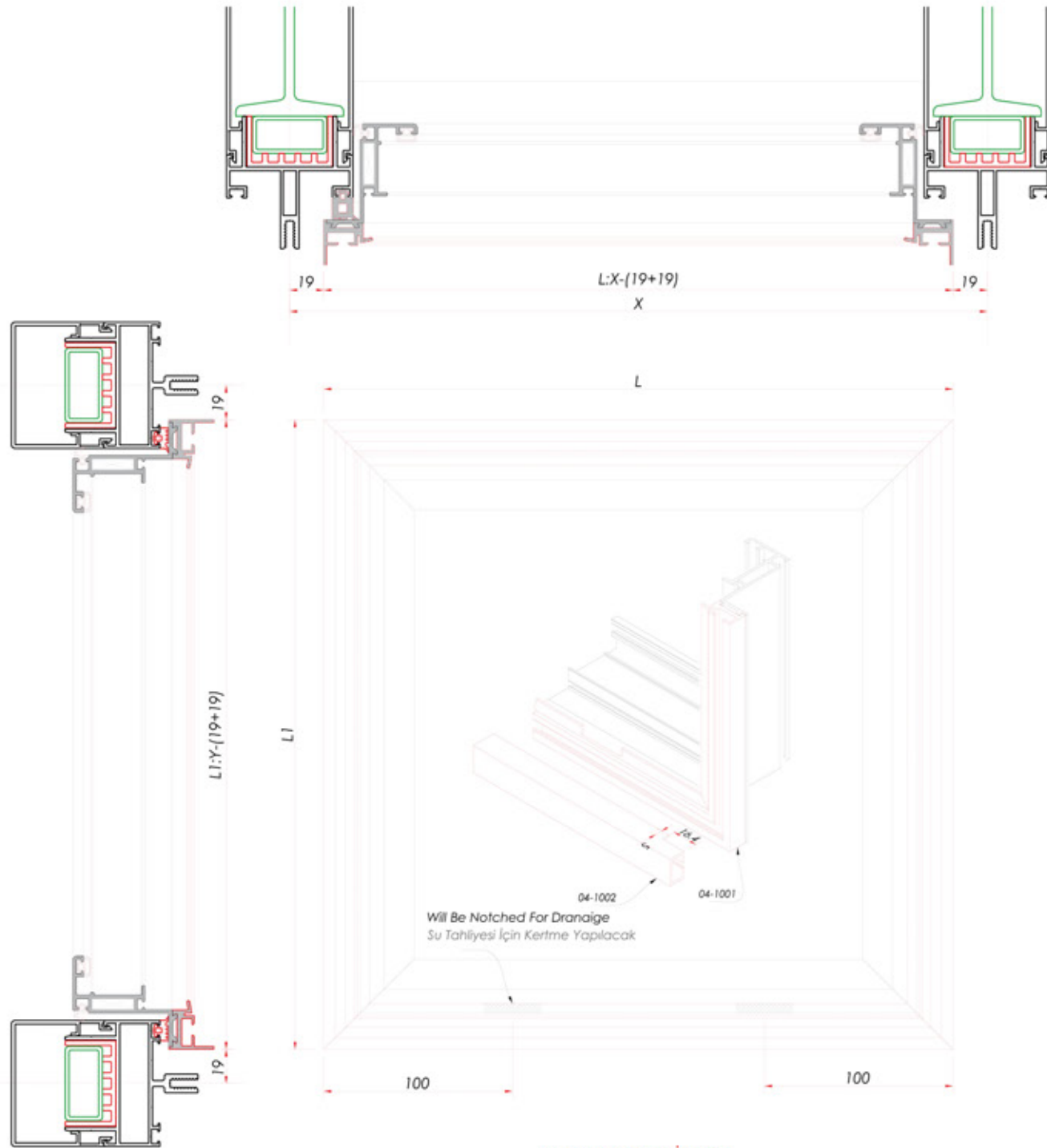
**CONCEALED VENT FRAME CUTTING DIMENSION**  
GİZLİ KANAT KASA KESİM ÖLÇÜSÜ

**ATTENTION / DİKKAT**  
**04-1001 Will be cut with the frame**  
 04-1001 Kasa ile birlikte kesilecek  
**04-1002 Folding Glass sizes are calculated due to the chosen system**  
 04-1002 Katlanır cam ölçüleri seçilen sisteme göre hesaplanır

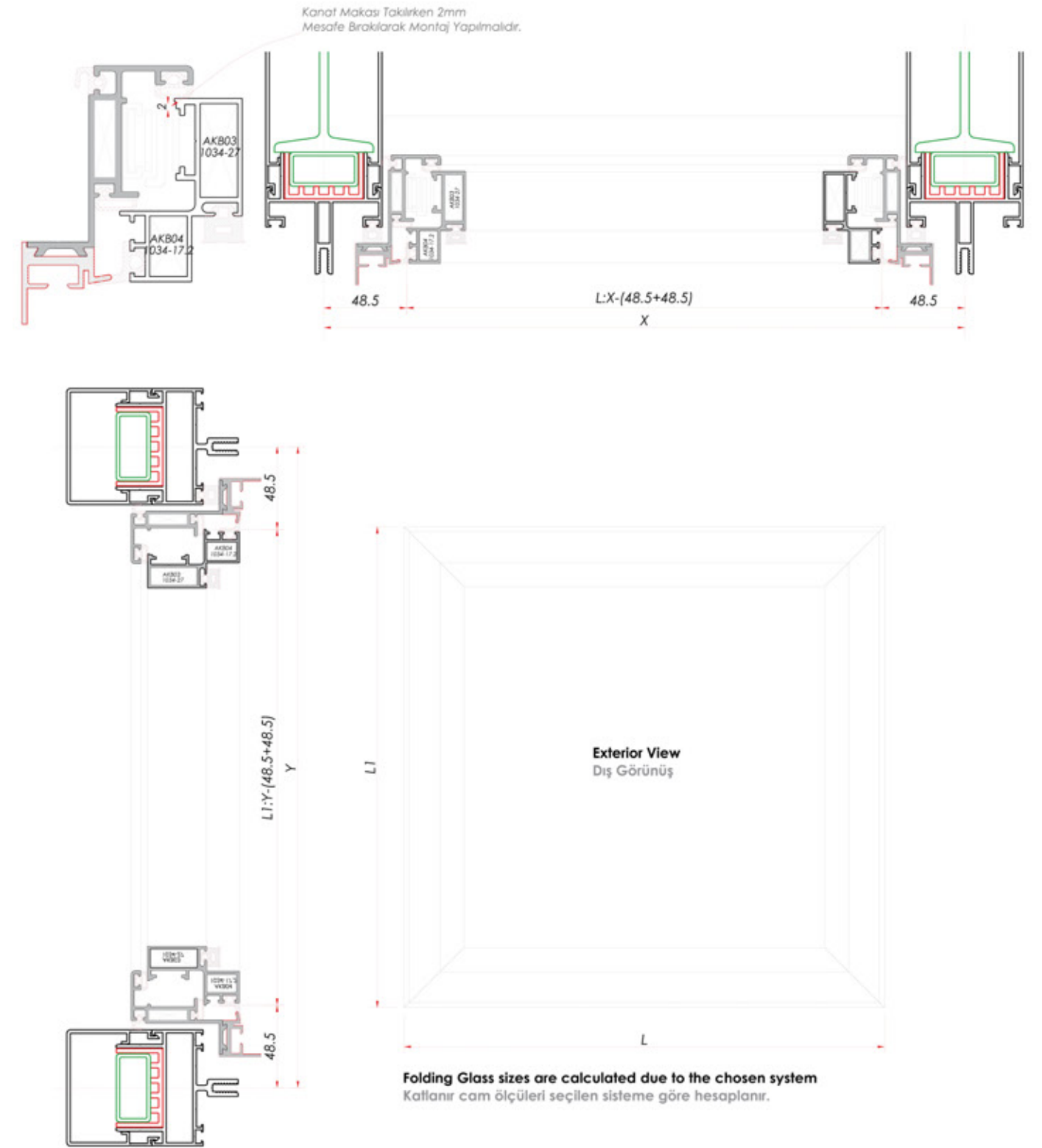

**Folding Glass sizes are calculated due to the chosen system**  
 Katlanır cam ölçüleri seçilen sisteme göre hesaplanır.

**Folding Glass sizes are calculated due to the chosen system**  
 Katlanır cam ölçüleri seçilen sisteme göre hesaplanır

**ALCAS®**



» **GENERAL PROFILES & ACCESSORIES**  
GENEL PROFİLLER VE AKSESUARLAR

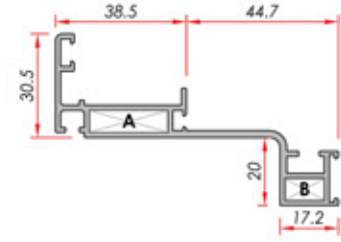

**Hidden Wing Frame**  
Gizli Kanat Kasa Paneli

System Code	Profile No	Weight kg
AF50 V 03	1022	1.008
A	AKB-1097-22	
B	AKB-1097-10	

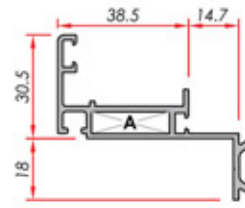

**Hidden Wing Frame**  
Gizli Kanat Kasa

System Code	Profile No	Weight kg
AF50 V 09	1096	0.706
A	AKB-1097 - 22	
B	---	

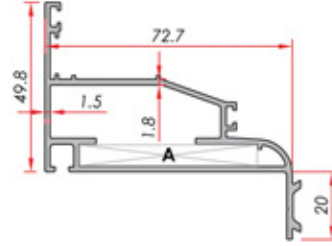

**Hidden Wing Frame**  
Gizli Kanat Kasa Paneli

System Code	Profile No	Weight kg
AF50 V 21	1171	1.201
A	AKB-1097-51	
B	---	

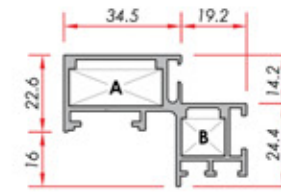

**Bonding Lath Narrow Glass Panel (Vent)**  
Bonding Çıtalı Dar Cam Paneli (Kanat)

System Code	Profile No	Weight kg
AF50 V 16	1049	0.883
A	AKB-1034-26	
B	AKB-1034-12	

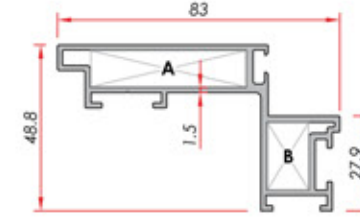

**Bonding Lath Glass Panel (Sash)**  
Bonding Çıtalı Cam Paneli (Kanat)

System Code	Profile No	Weight kg
AF50 V 20	1172	1.235
A	AKB-1034-45	
B	AKB-1730-11	

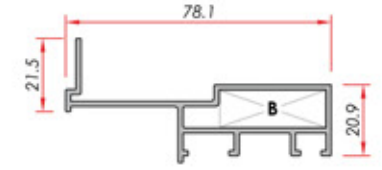

**Composite Panel**  
Kompoze Paneli

System Code	Profile No	Weight kg
AF50 V 13	1149	0.825
A	---	
B	AKB-1034-30	

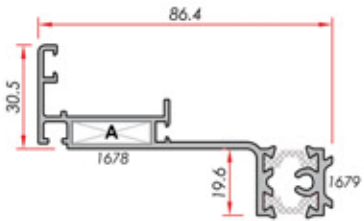

**Hidden Wing Frame**  
Gizli Kanat Kasa Paneli

System Code	Profile No	Weight kg
AF50 V 22	1679-1678	1.303
A	AKB-1097 - 22	
B	---	

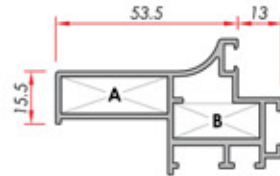

**Glazing Panel (Vent)**  
Cam Paneli (Kanat)

System Code	Profile No	Weight kg
AF50 V 01	1010	0.998
A	AKB-1034-30	
B	AKB-1034-24	

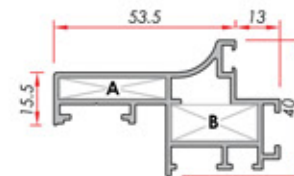

**Glazing Panel (Vent)**  
Cam Paneli (Kanat)

System Code	Profile No	Weight kg
AF50 V 14	1150	1.020
A	AKB-1097-30	
B	AKB-1034-24	

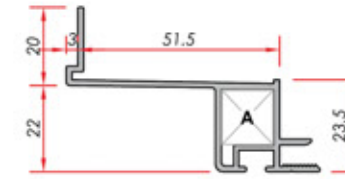

**Composite Panel**  
Kompoze Paneli

System Code	Profile No	Weight kg
AF50 V 18	1197	0.635
A	AKB-1328-12	
B	---	

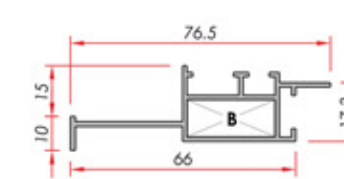

**Composite Panel**  
Kompoze Paneli

System Code	Profile No	Weight kg
AF50 V 08	1087	0.635
A	---	
B	AKB-1034-24	

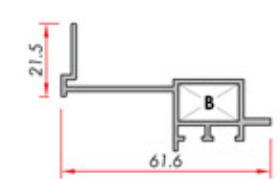

**Composite Panel**  
Kompoze Paneli

System Code	Profile No	Weight kg
AF50 V 11	1121	0.583
A	---	
B	AKB-1034-16	

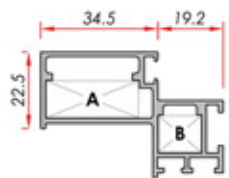

**Glazing Panel (Vent)**  
Cam Paneli (Kanat)

System Code	Profile No	Weight kg
AF50 V 12	1131	0.805
A	AKB-1034-26	
B	AKB-1034-12	

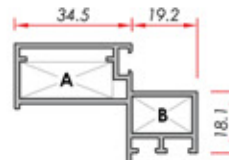

**Glazing Panel (Vent)**  
Cam Paneli (Kanat)

System Code	Profile No	Weight kg
AF50 V 07	1085	0.702
A	AKB-1034-26	
B	AKB-1034-16	

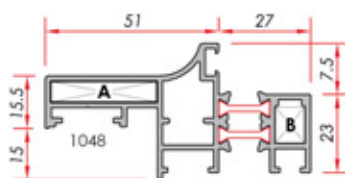

**Narrow Glass Panel (Vent)**  
Dar Cam Paneli (Kanat)

System Code	Profile No	Weight kg
AF50 V 19	1024-1048	1.382
A	AKB-1097-30	
B	AKB-1034-8	

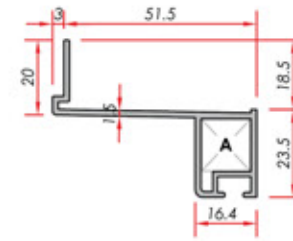

**Single Glass Panel**  
Tek Cam Paneli

System Code	Profile No	Weight kg
AF50 V 17	1196	0.570
A	AKB-1328-12	
B	---	

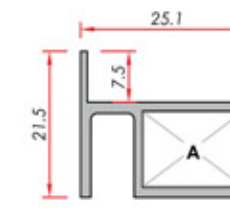

**Single Glass Panel**  
Tek Cam Paneli

System Code	Profile No	Weight kg
AF50 V 10	1109	0.309
A	AKB-1034-14	
B	---	

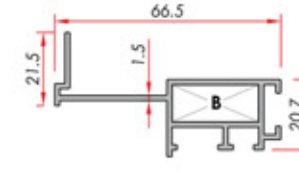

**Spandrel Panel**  
Spandrel Paneli

System Code	Profile No	Weight kg
AF50 V 02	1045	0.723
A	---	
B	AKB-1034 - 24	

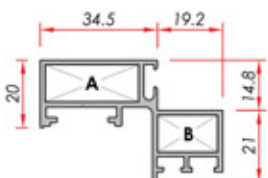

**Narrow Glass Panel (Vent)**  
Dar Cam Paneli (Kanat)

System Code	Profile No	Weight kg
AF50 V 15	1151	0.772
A	AKB-1034-26	
B	AKB-1034-16	

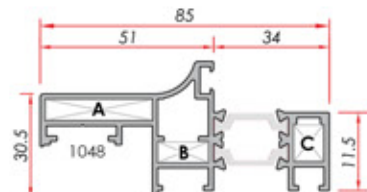

**Insulated Glazing Panel (Sash)**  
Yalıtımlı Cam Paneli (Kanat)

System Code	Profile No	Weight kg
AF50 V 23	1024-1048	1.457
A	AKB-1097-30	
B	AKB-1097-14	
C	AKB-1034-8	

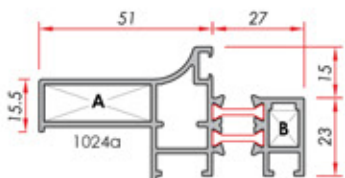

**Insulated Glazing Panel (Sash)**  
Yalıtımlı Cam Paneli (Kanat)

System Code	Profile No	Weight kg
AF50 V 05	1024-1024a	1.210
A	AKB-1034 - 30	
B	AKB-1097 - 8	

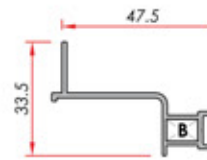

**Spandrel Panel**  
Spandrel Paneli

System Code	Profile No	Weight kg
AF50 V 04	1023	0.408
A	---	
B	AKB-1097 - 8	

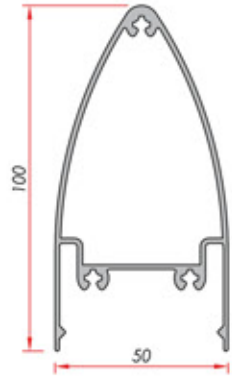

Cover  
Badem Kapak

System Code	Profile No	Weight kg
AF50 C 01	1015	1.365

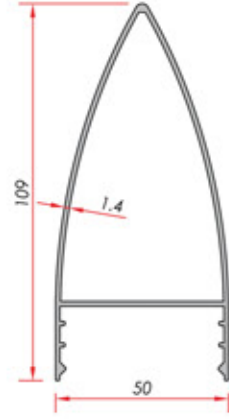

Cover  
Badem Kapak

System Code	Profile No	Weight kg
AF50 C 10	1184	1.100

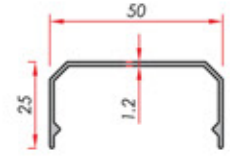

Cover  
Dikey Kapak

System Code	Profile No	Weight kg
AF50 C 02	1016	0.330

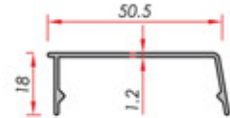

Cover  
Yatay Kapak

System Code	Profile No	Weight kg
AF50 C 03	1017	0.294

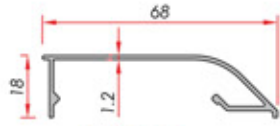

Skylight Cover  
Skylight Kapak

System Code	Profile No	Weight kg
AF50 C 04	1018	0.385

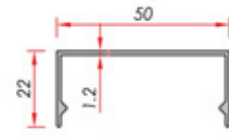

Cover  
Dikey Kapak

System Code	Profile No	Weight kg
AF50 C 07	1046	0.326



Cover  
Kapak

System Code	Profile No	Weight kg
AF50 C 09	1068	0.333

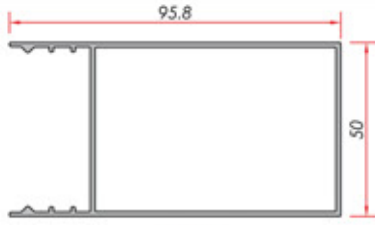

Cover  
Dikey Kapak

System Code	Profile No	Weight kg/m
AF50 C 12	1173	1.107

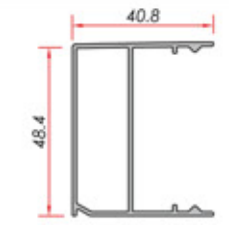

Cover  
Yatay Kapak

System Code	Profile No	Weight kg/m
AF50 C 13	1174	0.615



Cover  
Dikey Kapak

System Code	Profile No	Weight kg/m
AF50 C 15	1175	0.260

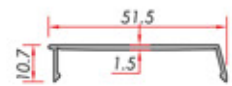

Cover  
Yatay Kapak

System Code	Profile No	Weight kg
AW50 C 16	1177	0.255

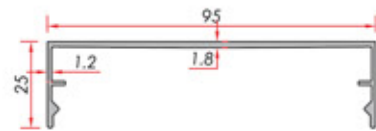

Cover  
Dikey Kapak

System Code	Profile No	Weight kg
AF50 C 18	1178	0.670

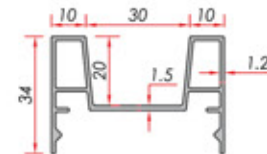

Cover  
Fugalı Kapak

System Code	Profile No	Weight kg
AF50 C 19	2057	0.630

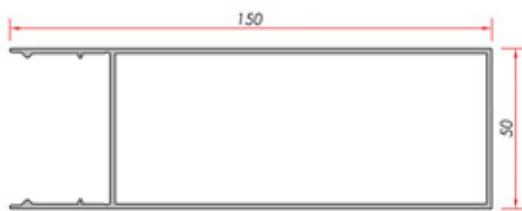

Cover  
Kapak

System Code	Profile No	Weight kg
AW50 C 20	1199	1.768

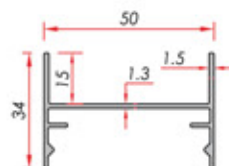

Cover  
Fugalı Kapak

System Code	Profile No	Weight kg
AW50 C 21	1879	0.485

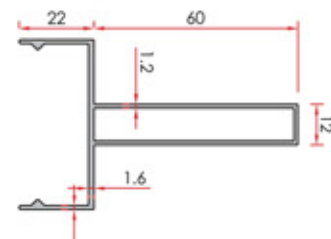

Cover  
Dikey Kapak

System Code	Profile No	Weight kg
AW50 C 28	5102	0.814

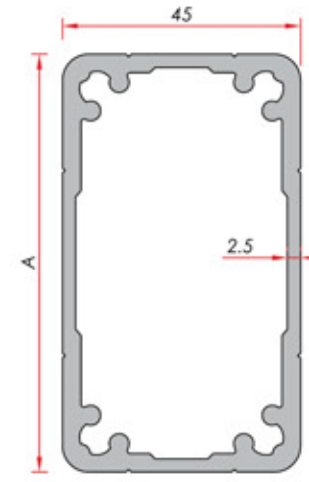

2 mm Mullion Dilatation  
2 mm Mulyon Dilatasyon

A	System Code	Profile No	Weight kg/mt	Jxx cm4	Jyy cm4	Mullion Profile Mulyon Profilii
59.5 mm	1032	1032	1.905	34.5	21.0	AF50 M 03 AF50 M 1803 AF50 EM 04 AF50 MH 03
79 mm	1031	1031	2.238	70.9	26.4	AF50 M 02 AF50 M 1802 AF50 MH 04 AF50 EM 03
103.5 mm	1030	1030	2.508	133.8	31.1	AF50 M 01 AF50 M 1801 AF50 EM 02 AF50 MH 01
128 mm	1088	1088	2.851	226.8	36.6	AF50 M 09 AF50 EM 01 AF50 MH 05

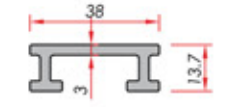

Half Mullion Dilatation  
Yarım Mulyon Dilatasyon

System Code	Profile No	Weight kg
1027	1027	0.586

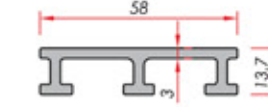

Half Mullion Dilatation  
Yarım Mulyon Dilatasyon

System Code	Profile No	Weight kg
1028	1028	0.889

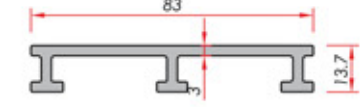

Half Mullion Dilatation  
Yarım Mulyon Dilatasyon

System Code	Profile No	Weight kg
1029	1029	1.086

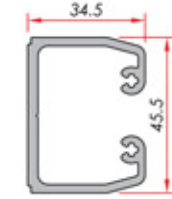

Mullion Dilatation  
Mulyon Dilatasyon

System Code	Profile No	Weight kg
1033	1033	1.059

Cutting Size Kesim Ölçüsü	25 mm	40 mm	55 mm	70 mm	90 mm	95 mm	100 mm	110 mm	145 mm
Transom Profile Transom Profili	AF 50 T 04 AF50 TH 05	AF50 LM 02 AF50 M 1804	AF50 T 03 AF50 T 08 AF50 ET 04 AF50 TH 01 AF50 M 1803	AF50 T 02 AF50 ET 03 AF50 TH 02 AF50 LM 01 AF50 M 1802	AF50 T 01 AF50 ET 02 AF50 TH 03	AF50 T 06	AF50 M 1801	AF50 T 07 AF50 ET 01 AF50 TH 04 AF50 M 1801	AF50 T 09

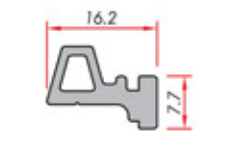

Panel Assembling Clips  
Kaset montaj Klipsi

System Code	Profile No	Weight kg
1282	1282	0.215

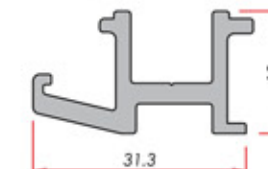

Panel Assembling Wedge  
Kaset Montaj Takozu

System Code	Profile No	Weight kg
4417	4417	0.525

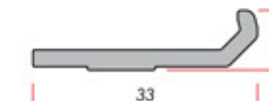

Glass Wedge  
Cam Takozu

System Code	Profile No	Weight kg
1026	1026	0.269

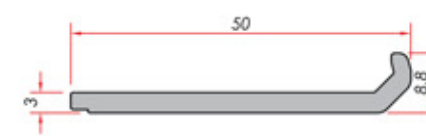

Glass Wedge  
Cam Takozu

System Code	Profile No	Weight kg
1680	1680	0.442

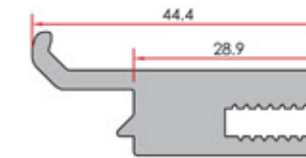

Glass Wedge  
Cam Takozu

System Code	Profile No	Weight kg
0991		1.027



Glass Wedge  
Cam Takozu

System Code	Profile No	Weight kg
1101	1101	0.284

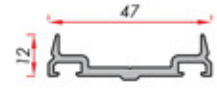

**Cover**  
Baskı Kapak

System Code	Profile No	Weight kg
AF50 C 05	1019	0.438

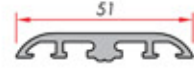

**Skylight Cover**  
Skylight Baskı Kapak

System Code	Profile No	Weight kg
AF50 C 06	1020	0.531

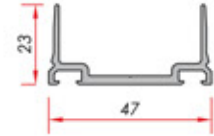

**Cover**  
Baskı Kapak

System Code	Profile No	Weight kg
AF50 C 11	1183	0.516

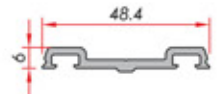

**Cover**  
Baskı Kapak

System Code	Profile No	Weight kg/m
AF50 C 14	1176	0.400

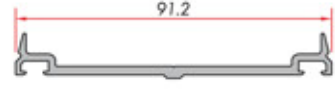

**Cover**  
Baskı Kapak

System Code	Profile No	Weight kg/m
AF50 C 17	1179	0.747

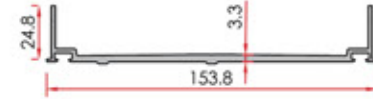

**Cover**  
Baskı Kapak

System Code	Profile No	Weight kg/m
AF50 C 22	1180	1.571

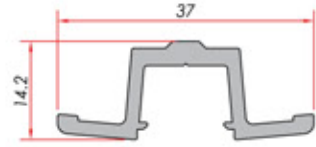

**Cover**  
Derz Kapak Profili

System Code	Profile No	Weight kg/m
AF50 A 05	1025	0.365

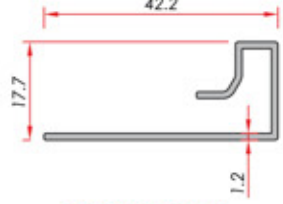

**Dilatation Profile**  
Dilatasyon Kapak

System Code	Profile No	Weight kg
AF50 A 02	1042	0.265



**Single Glass Bead**  
Tek Cam Çıtası

System Code	Profile No	Weight kg
AF50 A 03	1021	0.184

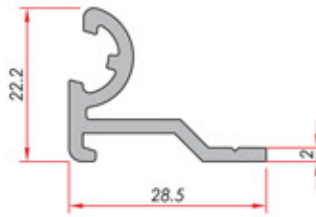

**Corner**  
Köşe Dönüş Dış

System Code	Profile No	Weight kg
AF50 A 06	1040	0.347

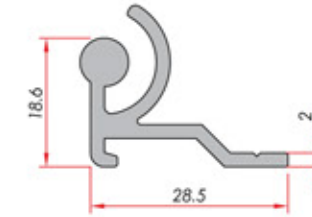

**Corner**  
Köşe Dönüş İç

System Code	Profile No	Weight kg
AF50 A 07	1041	0.350

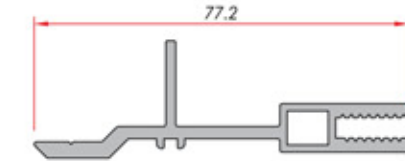

**Half Mullion Adapter**  
Yarım Mulyon Adaptörü

System Code	Profile No	Weight kg
AF50 A 01	1011	1.030

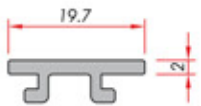

**Bonding Bead**  
Bonding Çıtası

System Code	Profile No	Weight kg/m
AF50 A 08	1043	0.154

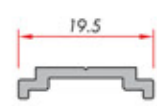

**Stem**  
Tij

System Code	Profile No	Weight kg
AF50 A 10	1375	0.126

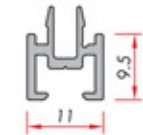

**Single Glass Bead**  
Tek Cam Çıtası

System Code	Profile No	Weight kg
AF50 A 12	1106	0.141

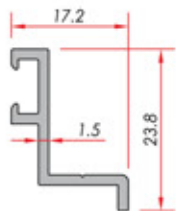

**Adaptor**  
Adaptör

System Code	Profile No	Weight kg/m
AF50 A 17	1182	0.182

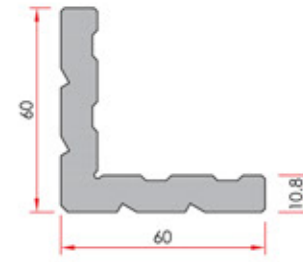

**Corner Cleat**  
Köşe Takozu

System Code	Profile No	Weight kg
1034	1034	2.967

Accessory Code	Profile Code	Cutting Size
----------------	--------------	--------------

AKB-1034-8.5	AF50 V 05 (1024) AF50 V 19 (1024) AF50 V 23 (1024)	8.5 mm
AKB-1034-12.5	AF50 V16 (1049) AF50 V 12 (1131)	12.5 mm
AKB-1034-14.4	AF50 V 10 (1109)	14.4 mm
AKB-1034-17.2	AF50 V 15 (1151) AF50 V 07 (1085) AF50 V 11 (1121)	17.2 mm
AKB-1034-25	AF50 V 01 (1010) AF50 V 02 (1045) AF50 V 08 (1087) AF50 V 14 (1150)	25 mm
AKB-1034-27	AF50 V 15 (1151) AF50 V 16 (1049) AF50 V 07 (1085) AF50 V 12 (1131)	27 mm
AKB-1034-31	AF50 V 01 (1010) AF50 V 05 (1024) AF50 V 13 (1149)	31 mm
AKB-1034-45.5	AF50 V 20 (1172)	45.5 mm

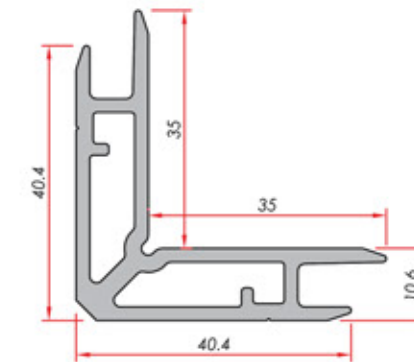

**Corner Cleat**  
Köşe Takozu

System Code	Profile No	Weight kg
1297	1297	1.031

System Code	Profile No	Cutting Size
-------------	------------	--------------

AKB-1034-12.5	AF50 V 16 (1049)	12.5 mm
AKB-1034-17.2	AF50 V 15 (1151) AF50 V 11 (1121)	17.2 mm
AKB-1034-27	AF50 V 15 (1151) AF50 V 16 (1049)	27 mm

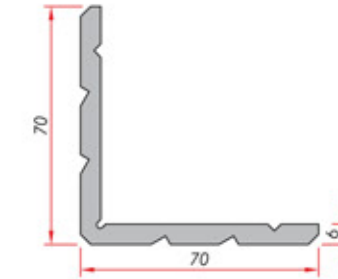

**Corner Cleat**  
Köşe Takozu

System Code	Profile No	Weight kg
1097	1097	2.032

Accessory Code	Profile Code	Cutting Size
----------------	--------------	--------------

AKB-1097-9	AF50 V 04 (1023)	9 mm
AKB-1097-11	AF50 V 03 (1022)	11 mm
AKB-1097-14.5	AF50 V 01 (1010) AF50 V 23 (1048)	14.5 mm
AKB-1097-22.5	AF50 V 03 (1022) AF50 V 09 (1096) AF50 V 22 (1678)	22.5 mm
AKB-1097-31	AF50 V 14 (1150) AF50 V 19 (1048)	31 mm
AKB-1097-52	AF50 V 21 (1171)	52 mm

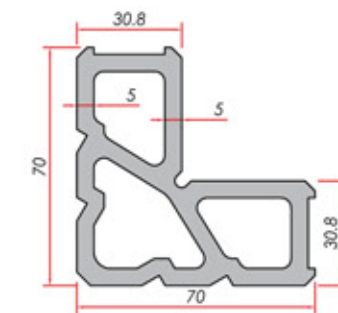

**Corner Cleat**  
Köşe Takozu

System Code	Profile No	Weight kg
1329	1329	4.388



**Corner Cleat**  
Köşe Takozu

System Code	Profile No	Weight kg
1328	1328	3.977

**Corner Cleat**  
Köşe Takozu

System Code	Profile No	Cutting Size
AKB-1028-13	AF50 V 17 (1196) AF50 V 18 (1197)	13 mm

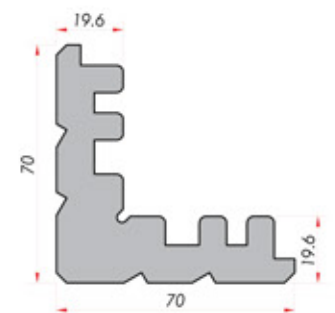









**Corner Cleat**  
Köşe Takozu









System Code	Profile No	Weight kg
1730	1730	5.059



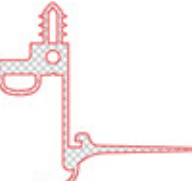





System Code	Profile No	Cutting Size
-------------	------------	--------------

AKB-1730-12	AKB-1730-12	12 mm
-------------	-------------	-------



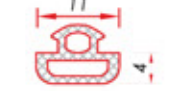

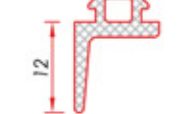



CODE / KOD	ACCESSORIES / AKSESUAR	DESCRIPTION / AÇIKLAMA
01-1002		325-350 mt Koli-Packing
01-1003		250 mt Koli-Packing
01-1005		200 mt Koli-Packing
01-1007		165 mt Koli-Packing
01-1008		120 mt Koli-Packing
01-1009		130 mt Koli-Packing
01-1010		120 mt Koli-Packing
01-1012		117 mt Koli-Packing





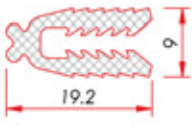
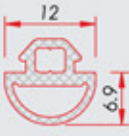



CODE / KOD	ACCESSORIES / AKSESUAR	DESCRIPTION / AÇIKLAMA
01-1014		83 mt Koli-Packing
01-1016		75 mt Koli-Packing
01-1103		230 mt Koli-Packing
01-1106		145 mt Koli-Packing
01-1108		135 mt Koli-Packing
01-1110		125 mt Koli-Packing
01-1111		100 mt Koli-Packing
01-1117		75 mt Koli-Packing





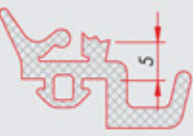
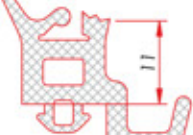

CODE / KOD	ACCESSORIES / AKSESUAR	DESCRIPTION / AÇIKLAMA
01-1120		70 mt Koli-Packing
01-1121		85 mt Koli-Packing
01-1122		58 mt Koli-Packing
01-1203		215 mt Koli-Packing
01-1211		95 mt Koli-Packing
01-1215		130 mt Koli-Packing
01-1258		125 mt Koli-Packing
01-1264		80 mt Koli-Packing



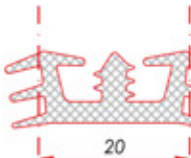
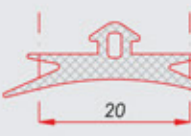

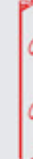
CODE / KOD	ACCESSORIES / AKSESUAR	DESCRIPTION / AÇIKLAMA
01-1266		75 mt Koli-Packing
01-1303		230 mt Koli-Packing
01-1304		150 mt Koli-Packing
01-1314		150 mt Koli-Packing
01-1404		230-270 mt Koli-Packing
01-1410		115 mt Koli-Packing
01-1412		215 mt Koli-Packing
01-1419		175 mt Koli-Packing

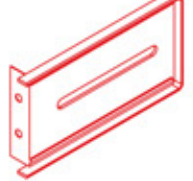
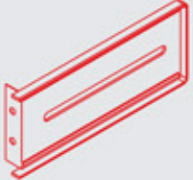

CODE / KOD	ACCESSORIES / AKSESUAR	DESCRIPTION / AÇIKLAMA
01-1431		150 mt Koli-Packing
01-1450		270 mt Koli-Packing
01-1451		450 mt Koli-Packing
01-1452		250 mt Koli-Packing
01-1453		150 mt Koli-Packing
01-1454		175 mt Koli-Packing
01-1457		365 mt Koli-Packing
01-1460		115 mt Koli-Packing
01-1503		155 mt Koli-Packing

CODE / KOD	ACCESSORIES / AKSESUAR	DESCRIPTION / AÇIKLAMA
01-1505		115 mt Koli-Packing
01-1507		95 mt Koli-Packing
01-1510		100 mt Koli-Packing
01-1512		75 mt Koli-Packing
01-1514		65 mt Koli-Packing
01-1605		90 mt Koli-Packing
01-1615		95 mt Koli-Packing
01-1621		65 mt Koli-Packing
01-2033		375 mt Koli-Packing

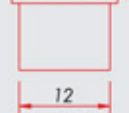
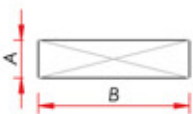
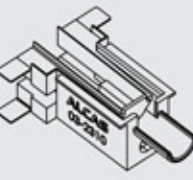
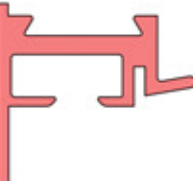
CODE / KOD	ACCESSORIES / AKSESUAR	DESCRIPTION / AÇIKLAMA
02-1001		50 mt Koli-Packing
02-1002		100 mt Koli-Packing
02-1101		50 mt Koli-Packing
03-1002		Transom Insulation Gasket Transom Yalıtım Contası 1 Pack Contains 100 Pieces 1 Pakette 100 Adet
03-1003		Side Coverings Badem Kapak Yan Kapamaları 1 Pack Contains 100 Pieces 1 Pakette 100 Adet
03-1004		Side Coverings Badem Kapak Yan Kapamaları 1 Pack Contains 100 Pieces 1 Pakette 100 Adet
03-1065		65mm Transom Dilatation Gasket 65 mm Transom Genleşme Contası 1 Pack Contains 50 Pieces 1 Pakette 50 Adet
03-1080		80 mm Transom Dilatation Gasket 80 mm Transom Genleşme Contası 1 Pack Contains 50 Pieces 1 Pakette 50 Adet







CODE / KOD	ACCESSORIES / AKSESUAR	DESCRIPTION / AÇIKLAMA																												
03-1100		100 mm Transom Dilatation Gasket 100 mm Transom Genleşme Contası 1 Pack Contains 50 Pieces 1 Pakette 50 Adet																												
03-1128		128 mm Transom Dilatation Gasket 128 mm Transom Genleşme Contası 1 Pack Contains 50 Pieces 1 Pakette 50 Adet																												
03-1244		244 mm Transom Dilatation Gasket 244 mm Transom Genleşme Contası 1 Pack Contains 50 Pieces 1 Pakette 50 Adet																												
03-2010		12 mm Installation cap 12 mm Montaj Tapası 1 Pack Contains 100 Pieces 1 Pakette 100 Adet																												
03-2082 03-2084 03-2202 03-2203 03-2205 03-2252 03-2253 03-2255 03-2282 03-2283 03-2285		<table border="1"> <thead> <tr> <th>A</th> <th>B</th> <th>A</th> <th>B</th> </tr> </thead> <tbody> <tr> <td>2</td> <td>8</td> <td>3</td> <td>25</td> </tr> <tr> <td>4</td> <td>8</td> <td>5</td> <td>25</td> </tr> <tr> <td>2</td> <td>20</td> <td>2</td> <td>28</td> </tr> <tr> <td>3</td> <td>20</td> <td>3</td> <td>28</td> </tr> <tr> <td>5</td> <td>20</td> <td>5</td> <td>28</td> </tr> <tr> <td>2</td> <td>25</td> <td></td> <td></td> </tr> </tbody> </table>	A	B	A	B	2	8	3	25	4	8	5	25	2	20	2	28	3	20	3	28	5	20	5	28	2	25		
A	B	A	B																											
2	8	3	25																											
4	8	5	25																											
2	20	2	28																											
3	20	3	28																											
5	20	5	28																											
2	25																													
03-2310		Gutter Çörten 1 Pack Contains 25 Pieces 1 Pakette 25 Adet																												
04-1001		Concealed Vent PVC Frame Exterior Gizli Kanat Kasa Plastiği Dış Order Length 3 mt Sipariş Boyu 3 mt																												
		Concealed Vent PVC Frame Exterior Gizli Kanat Kasa Plastiği Dış Order Length 3 mt Sipariş Boyu 3 mt																												

CODE / KOD	ACCESSORIES / AKSESUAR	DESCRIPTION / AÇIKLAMA
04-1003		Filling Silicone Strengthening (TPV) Dolgu Silikonu Besleme Fiti (TPV) 100 mt/Koli
04-1005		Mulyon-Transom Insulation PVC Mulyon-Transom Yalıtım Plastiği Order Length 3 mt Sipariş Boyu 3 mt
04-1011		Mulyon PVC Heat Insulation Mulyon Isı Yalıtım Plastiği Order Length 3 mt Sipariş Boyu 3 mt
04-1019		Mulyon PVC Heat Insulation Mulyon Isı Yalıtım Plastiği Order Length 3 mt Sipariş Boyu 3 mt
04-1029		Mulyon PVC Heat Insulation Mulyon Isı Yalıtım Plastiği Order Length 3 mt Sipariş Boyu 3 mt
05-1001		(T) Connection (T) Bağlantı 1 Pack Contains 50 Pieces 1 Pakette 50 Adet
05-1002		Espagnolette Pin Counter İspanyolet Pim Karşılığı 1 Pack Contains 50 Pieces 1 Pakette 50 Adet
05-1003		Pieces / Adet





CODE / KOD	ACCESSORIES / AKSESUAR	DESCRIPTION / AÇIKLAMA
06-1001		Cassette Side Holder Kaset Yan Tutucu 1 Pack Contains 100 Pieces 1 Pakette 100 Adet
06-1002		Cassette Side Holder Kaset Yan Tutucu 1 Pack Contains 100 Pieces 1 Pakette 100 Adet
06-1003		AF50 V01,02,05,08,13 Cassette Top Holder Kaset Üst Tutucu 1 Pack Contains 100 Pieces 1 Pakette 100 Adet
06-1005		AF50 V07,11,12,15,16 Cassette Holder Kaset Tutucu 1 Pack Contains 100 Pieces 1 Pakette 100 Adet
06-1007		AF50 V07,11,12,15,16 Cassette Wedge Kaset Takozu 1 Pack Contains 50 Pieces 1 Pakette 50 Adet
06-1008		AF50 V07,11,12,15,16 Cassette Wedge Kaset Takozu 1 Pack Contains 50 Pieces 1 Pakette 50 Adet
06-1009		Surface 20 mic. Black Anodized Yüzey 20 mic. Siyah Eloksal 1 Pack Contains 50 Pieces 1 Pakette 50 Adet
06-1010		Condense Channel -Dilatation Insulation Profile Kondens Kanalı Dilatasyon Yalıtım Profili 1 Pack Contains 100 Pieces 1 Pakette 100 Adet



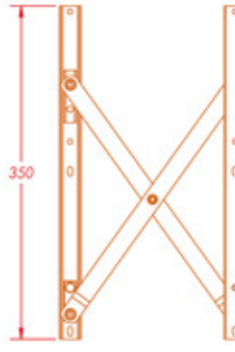
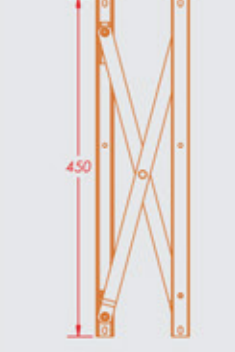
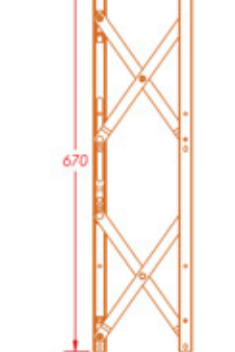
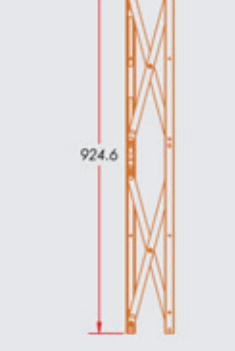

CODE / KOD	ACCESSORIES / AKSESUAR	DESCRIPTION / AÇIKLAMA
06-1011		Condense Channel -Dilatation Insulation Profile Kondens Kanalı Dilatasyon Yalıtım Profili 1 Pack Contains 100 Pieces 1 Pakette 100 Adet
06-1012		Assembling Clips Montaj Klipsi 1 Pack Contains 100 Pieces 1 Pakette 100 Adet
06-1013		External Corner Mounting Clips Dış Köşe Montaj Klipsi 1 Pack Contains 100 Pieces 1 Pakette 100 Adet
06-1014		Assembling Clips Internal Corner İç Köşe Montaj Klipsi 1 Pack Contains 100 Pieces 1 Pakette 100 Adet
06-1015		Assembling Angle Clips Ağı Montaj Klipsi 1 Pack Contains 100 Pieces 1 Pakette 100 Adet
06-1133		Aluminium Glazing Cleat Aluminyum Cam Takozu 1 Pack Contains 50 Pieces 1 Pakette 50 Adet
06-1150		Aluminium Glazing Cleat Aluminyum Cam Takozu 1 Pack Contains 50 Pieces 1 Pakette 50 Adet
06-1227		Aluminium Glazing Cleat Aluminyum Cam Takozu 1 Pack Contains 50 Pieces 1 Pakette 50 Adet

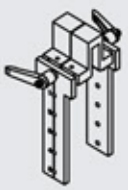
CODE / KOD	ACCESSORIES / AKSESUAR	DESCRIPTION / AÇIKLAMA
06-1345		Aluminium Glazing Cleat Aluminyum Cam Takozu 1 Pack Contains 50 Pieces 1 Pakette 50 Adet
09-1530 09-1531 09-1532 09-1533 09-1534		One Way Axial Handle Tek Yöne Eksenel Kol Anodizing / Nat. Eloksal White / Beyaz Brown / Kahverengi Raw / Ham Special / Özel Renk
09-1540 09-1541 09-1542 09-1543 09-1544		Dual Way Axial Handle Çift Yöne Eksenel Kol Anodizing / Nat. Eloksal White / Beyaz Brown / Kahverengi Raw / Ham Special / Özel Renk
09-2700		Espagnolette Pin İspanyolet Pimi 1 Pack Contains 50 Pieces 1 Pakette 50 Adet
09-2701		Corner Transfer Espagnolette İspanyolet Köşe Aktarma 1 Pack Contains 30 Pieces 1 Pakette 30 Adet

CODE / KOD	ACCESSORIES / AKSESUAR	DESCRIPTION / AÇIKLAMA
09-3000		Concealed Vent Facade Gizli Kanat Cephe Makası Takım (1 Takımda sağ ve sol olmak üzere 2 adet makas vardır.) SPT22 567 mm 1090-1500 mm 100 Kg-20°
09-3001		Concealed Vent Facade Gizli Kanat Cephe Makası Takım (1 Takımda sağ ve sol olmak üzere 2 adet makas vardır.) SPT22W 567 mm 1500-2000 mm 100 Kg-20°
09-3002		Concealed Vent Facade Gizli Kanat Cephe Makası Takım (1 Takımda sağ ve sol olmak üzere 2 adet makas vardır.) SPT26 680 mm 2000-2500 mm 180 Kg-20°
09-3003		Concealed Vent Facade Gizli Kanat Cephe Makası Takım (1 Takımda sağ ve sol olmak üzere 2 adet makas vardır.) SPTH16 415 mm 600-1100 mm 100 Kg-30°
09-3004		Concealed Vent Facade Gizli Kanat Cephe Makası Takım (1 Takımda sağ ve sol olmak üzere 2 adet makas vardır.) SPT16 415 mm 800-1100 mm 65 Kg-50°
09-3005		Concealed Vent Facade Gizli Kanat Cephe Makası Takım (1 Takımda sağ ve sol olmak üzere 2 adet makas vardır.) SPT12 313 mm 640-800 mm 50 Kg-50°

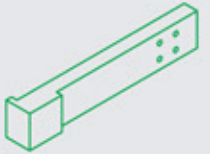
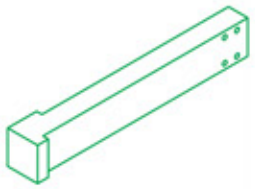
CODE / KOD	ACCESSORIES / AKSESUAR	DESCRIPTION / AÇIKLAMA
09-3010L 09-3010R		Hinges Code Makas Kodu P90350 Max. Vent Weight (Kg) Max. Kanat Ağırlığı 100 Min. Vent Height (mm) Min. Kanat Yüksekliği 350 Max. Vent Height (mm) Max. Kanat Yüksekliği 750 Max. Manual Opening Max. Manuel Açılım 150 Max. Motorised Opening Max. Motorlu Açılım 180 Manual Limit Stop Manuel Limit Stoplayıcı CB700
09-3011L 09-3011R		Hinges Code Makas Kodu P90450 Max. Vent Weight (Kg) Max. Kanat Ağırlığı 100 Min. Vent Height (mm) Min. Kanat Yüksekliği 450 Max. Vent Height (mm) Max. Kanat Yüksekliği 1000 Max. Manual Opening Max. Manuel Açılım 150 Max. Motorised Opening Max. Motorlu Açılım 250 Manual Limit Stop Manuel Limit Stoplayıcı CB571
09-3012L 09-3012R		Hinges Code Makas Kodu P90670 Max. Vent Weight (Kg) Max. Kanat Ağırlığı 200 Min. Vent Height (mm) Min. Kanat Yüksekliği 670 Max. Vent Height (mm) Max. Kanat Yüksekliği 1500 Max. Manual Opening Max. Manuel Açılım 150 Max. Motorised Opening Max. Motorlu Açılım 150 Manual Limit Stop Manuel Limit Stoplayıcı CB668
09-3013L 09-3013R		Hinges Code Makas Kodu P90950 Max. Vent Weight (Kg) Max. Kanat Ağırlığı 200 Min. Vent Height (mm) Min. Kanat Yüksekliği 930 Max. Vent Height (mm) Max. Kanat Yüksekliği 2000 Max. Manual Opening Max. Manuel Açılım 150 Max. Motorised Opening Max. Motorlu Açılım 250 Manual Limit Stop Manuel Limit Stoplayıcı CB571

CODE / KOD	ACCESSORIES / AKSESUAR	DESCRIPTION / AÇIKLAMA
10-1100		Steel Anchorage 100 100 lük Çelik Ankraj Pieces / Adet
10-1125		Steel Anchorage 125 125 lük Çelik Ankraj Pieces / Adet
10-1150		Steel Anchorage 150 150 lük Çelik Ankraj Pieces / Adet
10-1200		Transom Installation Model Transom Montaj Şablonu
10-1201		Mulyon Side Template Holder Mulyon Yan Tutucu Şablonu SPTH16 415 mm 1090-1500 mm 75 Kg

CODE / KOD	ACCESSORIES / AKSESUAR	DESCRIPTION / AÇIKLAMA
10-1202		Frame Side Holder Model Kaset Yan Tutucu Şablonu
10-1203		Frame Bottom Holder Model Kaset Alt Tutucu Şablonu
10-1300		Aluminium Foil Tape Aluminyum Folyo Bant Pieces (10mt) Adet (10mt)
10-3000 10-3001 10-3002 10-3003		Standart Filling Silicone 1 Pack Contains 25 Pieces Genel Amaçlı Dolgu Silikonu 1 Paketde 25 Adet Grey / Gri Transparent / Şeffaf White / Beyaz Black / Siyah
10-3010 10-3011 10-3012 10-3013		Neutral Filling Silicone 1 Pack Contains 25 Pieces Nötr Dolgu Silikonu 1 Paketde 25 Adet Grey / Gri Transparent / Şeffaf White / Beyaz Black / Siyah

**ISO 9001 SERTİFİKASI**



**QUALICOAT SERTİFİKASI**



**QUALANOD SERTİFİKASI**



**IATF 16949 SERTİFİKASI**



**TSE HASSAS PROFİLLER BELGESİ**



**TSE YÜZEY İŞLEM BELGESİ**



**TSE İMALATI YETERLİLİK BELGESİ**



**ISO 14001**



**OHSAS 18001 BELGESİ**



**FABRİKA ÜRETİM UYGUNLUK**



**CE BELGESİ**



**GOST-R SERTİFİKASI**



# ALCAS®

ALUMINIUM PROFILE SYSTEMS

444 36 44

alcas@alcas.com.tr

www.alcas.com.tr

Kaya Milenium Plaza Kat 7 No:139 Beykent / İstanbul +90212 871 1771

Velimeşe Islah OSB 129.Sok.11/1 Ergene / Tekirdağ +90282 6745175

alcasmetal

alcasaluminyum

alcasmetal

alcasmetal

alcasmetal



All designs, profiles and accessories listed in this catalog are © copyrighted and ® registered products. May not be copied, altered or posted online by any means.  
Bu katalogta yer alan tasarımlar, profiller ve aksesuarlar tescilli ve patentli ürünlerimizdir. Hiçbir şekilde kopyalanamaz ve taklit edilemez.

*Dünyanın yeni profil sistemi*

