

Project Name / Proje Adı : Voyage Otel Torba  
System / Sistem : AS55  
City / Şehir : Bodrum - Muğla - TÜRKİYE



ALCAS®

# AS55

55 mm Alcas Sliding System  
55 mm Alcas Sürme Sistemi

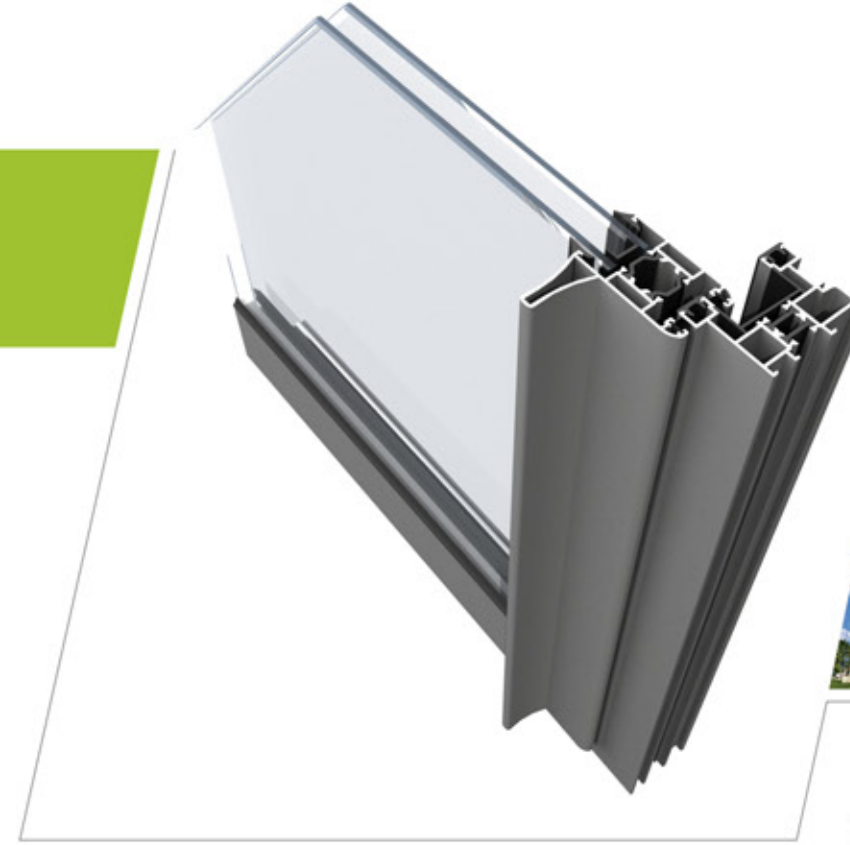

**ALCAS®** Türkiye, Avrupa, Ortadoğu ve Kuzey Afrika pazarı için dizayn ettiği mükemmel bir sürme serisi olan AS yalıtımlı ve yalıtımsız olarak iki farklı tipte ürün sunulmuştur. 2 ve 3 kanallı olarak dizayn edilen seri aynı anda 2, 3 ve 4 pencere olarak açılabilir. Zarif hatlara sahip serimiz turistik ve lüks otellerde, villa, rezidans, lüks restoran ve cafelerde kullanım alanı bulmakta, yer kaybını engellemekte, bulunduğu mekanın değerini artıracak bir estetiktedir.

AS serisinde kullanılan tüm aksesuarlar özenle üretilmektedir. Rulman tekerlekler yapılan testler neticesinde binlerce açılıp kapanmada deforme olmayacak paslanmaz çelikten üretilmekte, yine rayları deforme olmayı engellemek için paslanmaz sacdan bükülerek yapılmaktadır.

AS serisi kendi segmentinde Türkiye'nin en geniş profil seçeneğine ve tamamlanmış aksesuarlarına sahip bir seridir.

**ALCAS®** presents two different, insulated and non-insulated. AS sliding series designed for Turkish, European, Middle Eastern & North Africa markets. The series, having 2 & 3 channels, can also be opened as either 2, 3 or 4 windows. With its delicate and design it also has an area of use at touristic and luxury hotels, residences, restaurants & cafés. By reducing the loss of area, it also increases the worth of area.

All the accessories used in AS series are specially designed and produced. The results of roller wheel tests shows that our series are capable of working without deforming; thanks to its special stainless steel rollers and stainless sheet rails, even after thousands of opening/closing.

AS Series has the best series in Turkey with its completed accessory set and wide range of profiles.

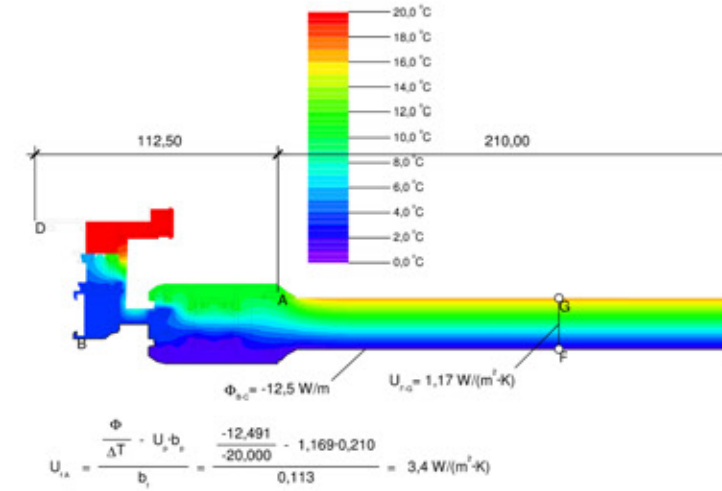

#### Descriptions / Tanımlamalar

	Brand <b>ALCAS®</b>	Marka <b>ALCAS®</b>	Profile type description Profil tip tanımlamaları
<b>S</b>	System Type Window	Sistem Tipi Pencere	<b>F</b> Frame Kasa
<b>55</b>	Series Length	Seri Genişliği	<b>M</b> Meeting Rail Orta Kayıt
<b>F</b>	Profile Type	Profil Tipi	<b>V</b> Vent Kanat
<b>01</b>	Group Location	Gruptaki Yeri	<b>A</b> Adapter Adaptör

#### Symbols / Semboller

	Corner block assembly with 45° cutting process 45° kesim işlemi köşe takozu ile birleştirme
	Milling process of merging with the vertical connection Kertme işlemi dik bağlantı ile birleştirme
	Cross-sectional aspect of strength Mükavemet kesit yönü



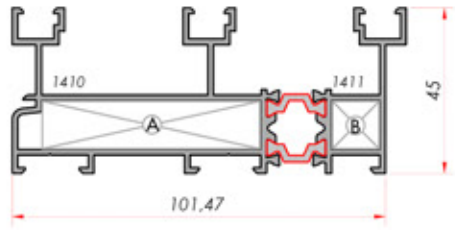

**Three Rail Frame**  
Üç Raylı Kasa

System Code	Profile No	Weight kg/m
AS55 TF 01	1410-1411	2.019
Jxx cm <sup>4</sup>	83.4	Jyy cm <sup>4</sup> 12.6
A	AKB-1422-59	
B	AKB-1422-12.6	

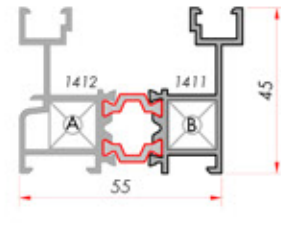

**Two Rail Frame**  
İki Raylı Kasa

System Code	Profile No	Weight kg/m
AS55 TF 02	1412-1411	1.373
Jxx cm <sup>4</sup>	17.5	Jyy cm <sup>4</sup> 8.0
A	AKB-1422-12.6	
B	AKB-1422-12.6	

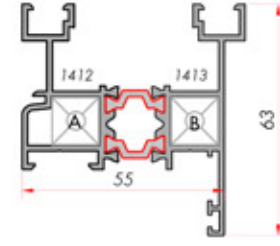

**Two Rail Frame (Flat Sill)**  
İki Raylı Kasa (Düz Pervazlı)

System Code	Profile No	Weight kg/m
AS55 TF 03	1412-1413	1.474
Jxx cm <sup>4</sup>	19.9	Jyy cm <sup>4</sup> 10.6
A	AKB-1422-12.6	
B	AKB-1422-12.6	

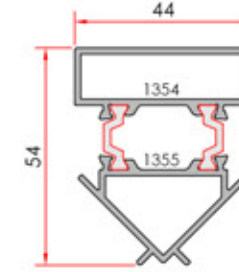

**90° Corner Adapter**  
90° Köşe Dönüş Adaptörü

System Code	Profile No	Weight kg/m
AW55 TC 04	1354-1355	1.189
Jxx cm <sup>4</sup>	10.2	Jyy cm <sup>4</sup> 7.4

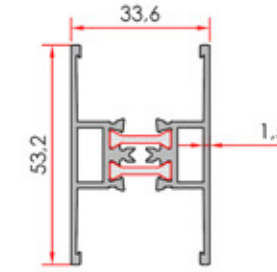

**Meeting Rail**  
Orta Kayıt

System Code	Profile No	Weight kg/m
AS55 TV 07	1420-1420	1.003
Jxx cm <sup>4</sup>	4.4	Jyy cm <sup>4</sup> 6.1

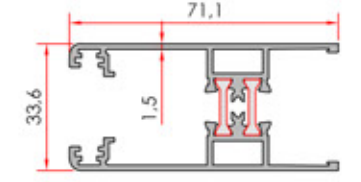

**Vent**  
Kanat

System Code	Profile No	Weight kg/m
AS55 TV 04	1421-1421	1.292
Jxx cm <sup>4</sup>	7.5	Jyy cm <sup>4</sup> 16.1

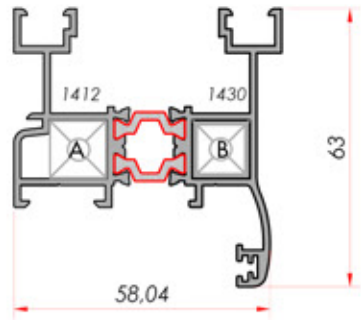

**Two Rail Sill Frame**  
İki Raylı Pervaz Kasa

System Code	Profile No	Weight kg/m
AS55 TF 04	1412-1430	1.500
Jxx cm <sup>4</sup>	21.5	Jyy cm <sup>4</sup> 11.2
A	AKB-1422-12.6	
B	AKB-1422-12.6	

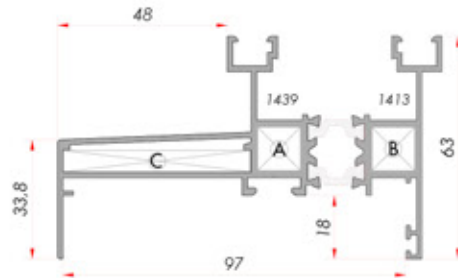

**Two Rail Sill Frame**  
İki Raylı Pervaz Kasa

System Code	Profile No	Weight kg/m
AS55 TF 05	1439-1413	2.016
Jxx cm <sup>4</sup>	78.19	Jyy cm <sup>4</sup> 12.92
A	AKB-1422-12.6	
B	AKB-1422-12.6	
C	AKB-1097-52.8	

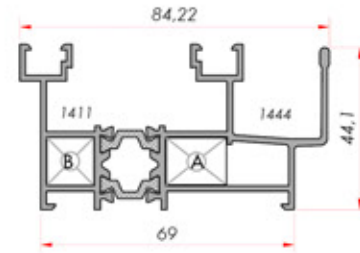

**Mosquito Netting Rail**  
Sineklik Raylı Kasa Profili

System Code	Profile No	Weight kg/m
AS55 TF 06	1444-1411	1600
Jxx	37.1	Jyy 9.7
A	AKB-1422-16.4	
B	AKB-1422-12.6	

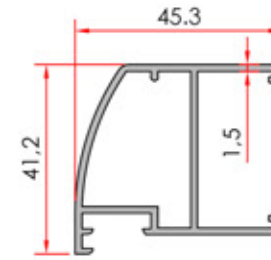

**Vent**  
Kanat

System Code	Profile No	Weight kg/m
AS55 TV 05	1419	0.730
Jxx cm <sup>4</sup>	5.4	Jyy cm <sup>4</sup> 4.8

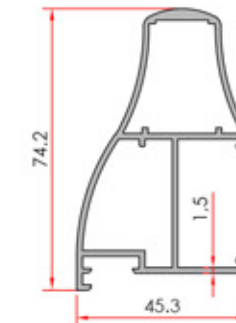

**Reinforced Vent**  
Takviyeli Kanat

System Code	Profile No	Weight kg/m
AS55 TV 06	1418	1.128
Jxx cm <sup>4</sup>	22.5	Jyy cm <sup>4</sup> 6.1

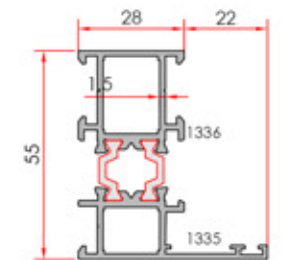

**Frame**  
Kasa

System Code	Profile No	Weight kg/m
AW55 TF 1503	1335-1336	1.245
Jxx cm <sup>4</sup>	14.6	Jyy cm <sup>4</sup> 4.8

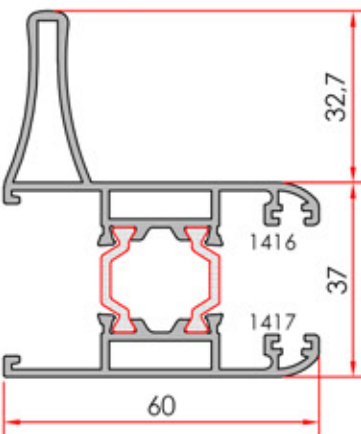

**Reinforced Vent**  
Takviyeli Kanat

System Code	Profile No	Weight kg/m
AS55 TV 02	1417-1416	1.550
Jxx cm <sup>4</sup>	26.4	Jyy cm <sup>4</sup> 10.7

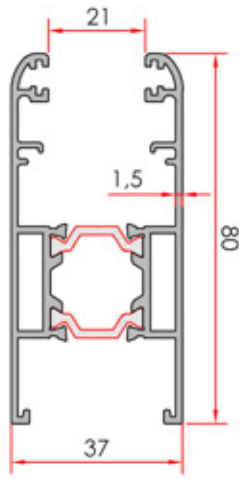

**Gear Vent**  
İspanyoloteli Kanat

System Code	Profile No	Weight kg/m
AS55 TV 03	1437-1437	1.500
Jxx cm <sup>4</sup>	24.3	Jyy cm <sup>4</sup> 11.1

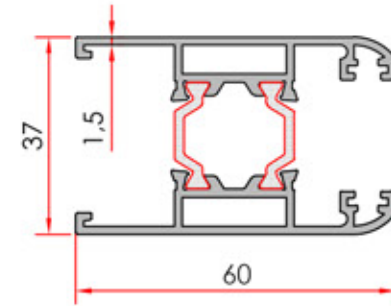

**Vent**  
Kanat

System Code	Profile No	Weight kg/m
AS55 TV 01	1417-1417	1.247
Jxx cm <sup>4</sup>	10.7	Jyy cm <sup>4</sup> 9.0

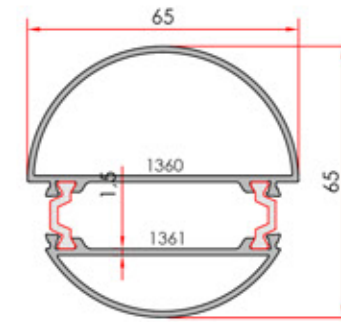

**Corner Profile**  
Köşe Dönüş Profili

System Code	Profile No	Weight kg/m
AW55 TC 03	1360-1361	1.486
Jxx cm <sup>4</sup>	22.6	Jyy cm <sup>4</sup> 17.4

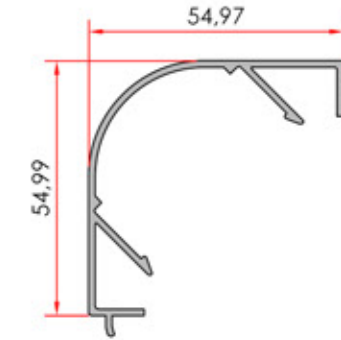

**90° Corner Adapter**  
90° Köşe Dönüş Adaptörü

System Code	Profile No	Weight kg/m
AW55 TC 05	1358	0.654

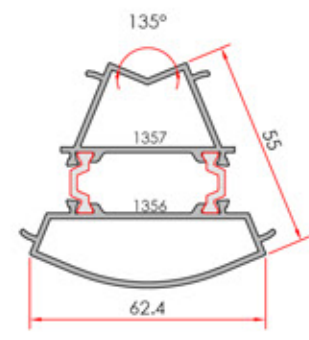

**135° Corner Adapter**  
135° Köşe Dönüş Adaptörü

System Code	Profile No	Weight kg/m
AW55 TC 01	1356-1357	1.401
Jxx cm <sup>4</sup>	15.6	Jyy cm <sup>4</sup> 14.6



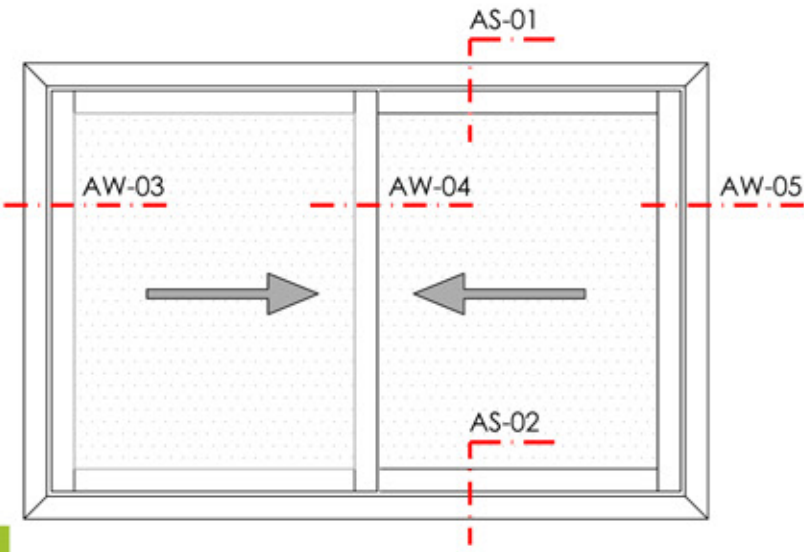

Exterior View - Dış Görünüş

<b>Glass Thickness</b> Cam Kalınlığı	Max. 24 mm
<b>Bearing Capacity</b> Rulman Taşıma Kapasitesi	Max. 150 kg

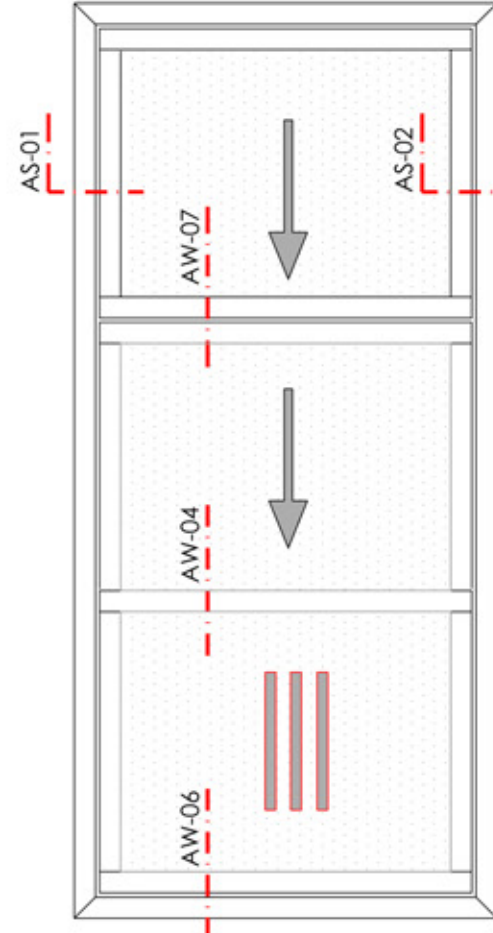
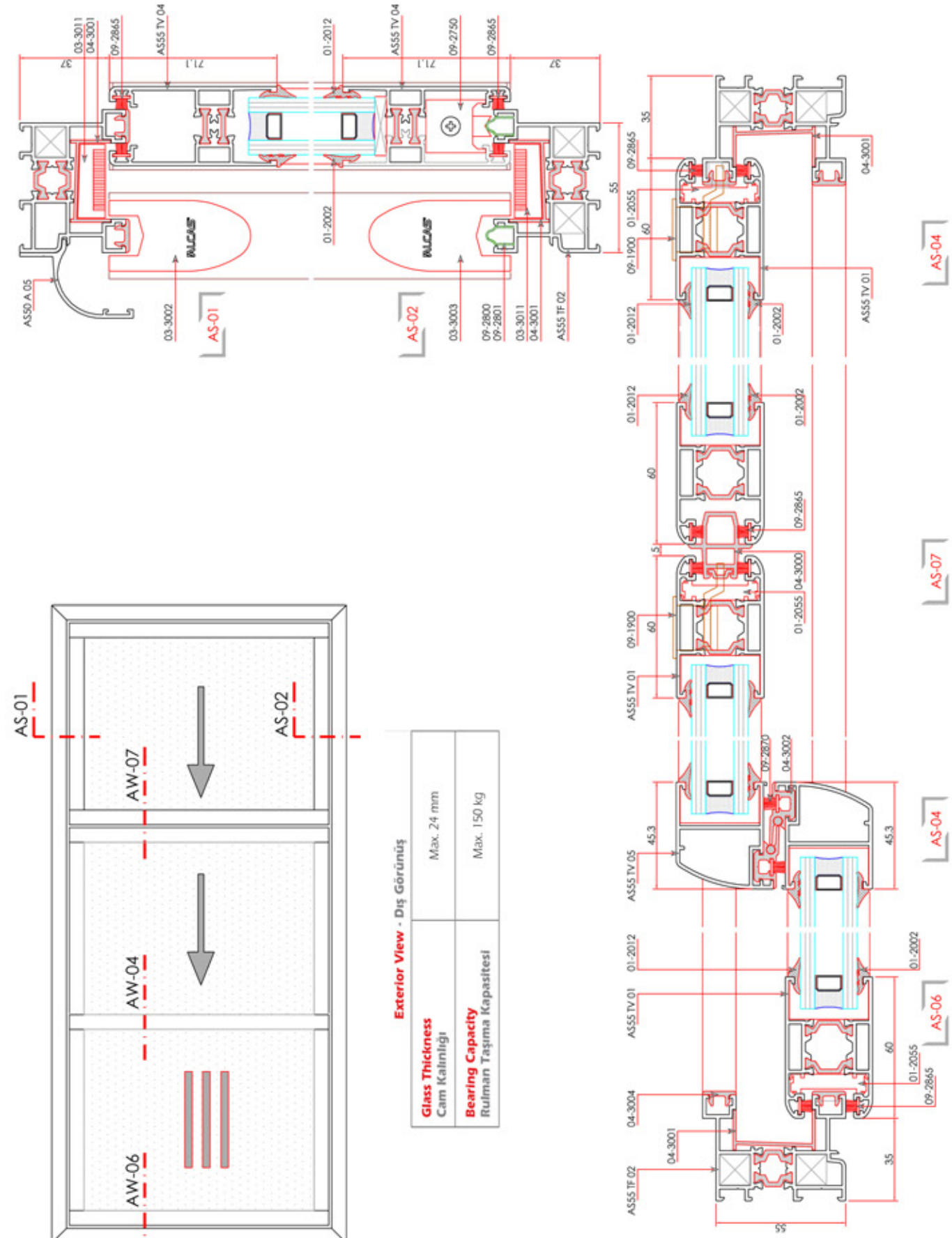
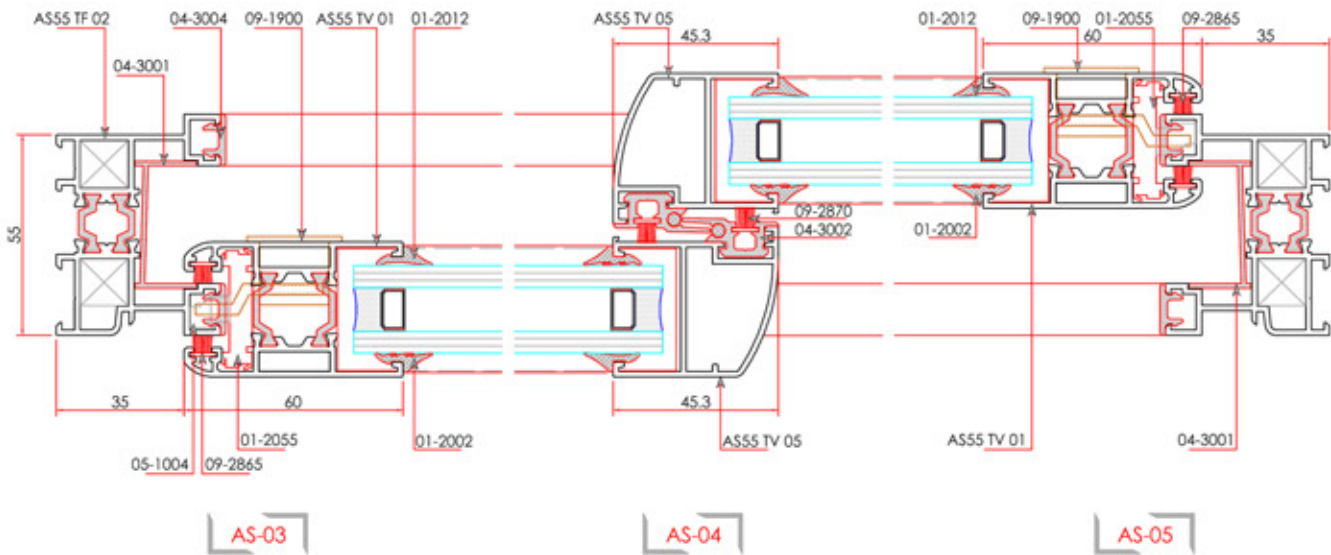
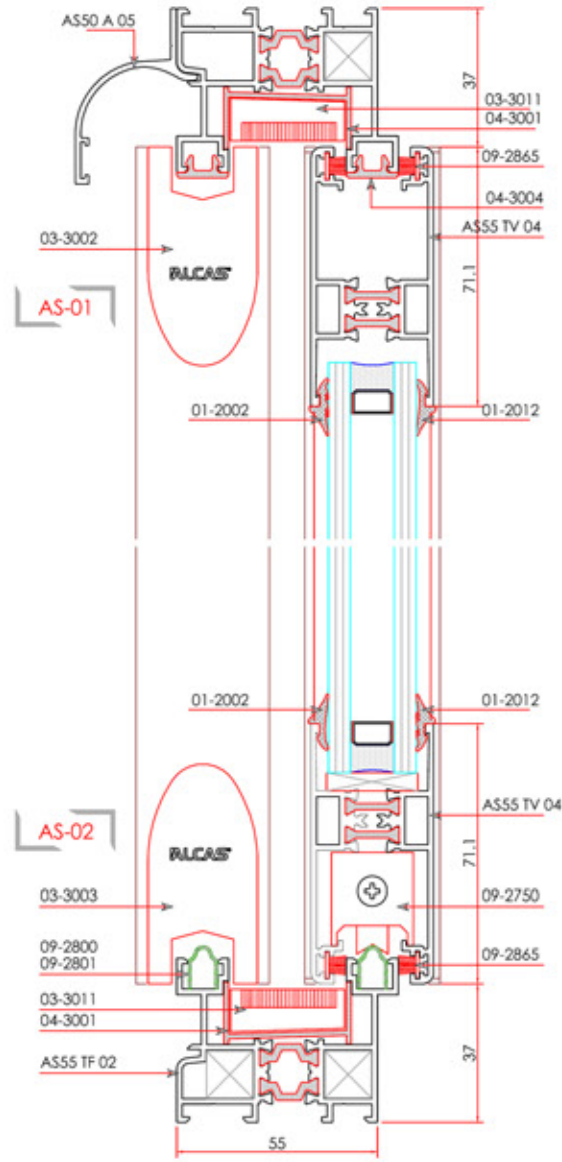

Exterior View - Dış Görünüş

<b>Glass Thickness</b> Cam Kalınlığı	Max. 24 mm
<b>Bearing Capacity</b> Rulman Taşıma Kapasitesi	Max. 150 kg









**VENT CUTTING SIZE**  
KANAT KESİM ÖLÇÜLERİ

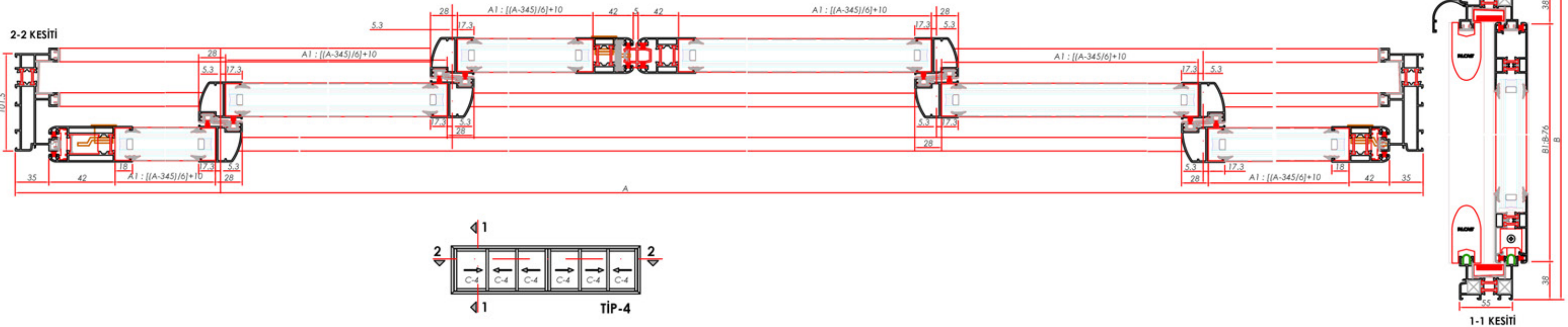
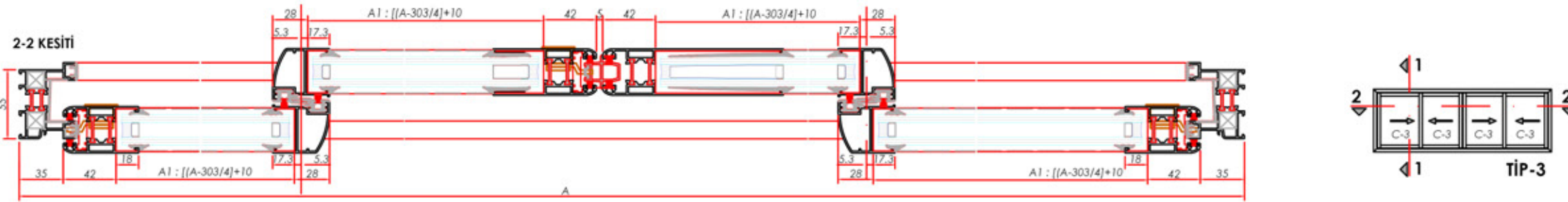
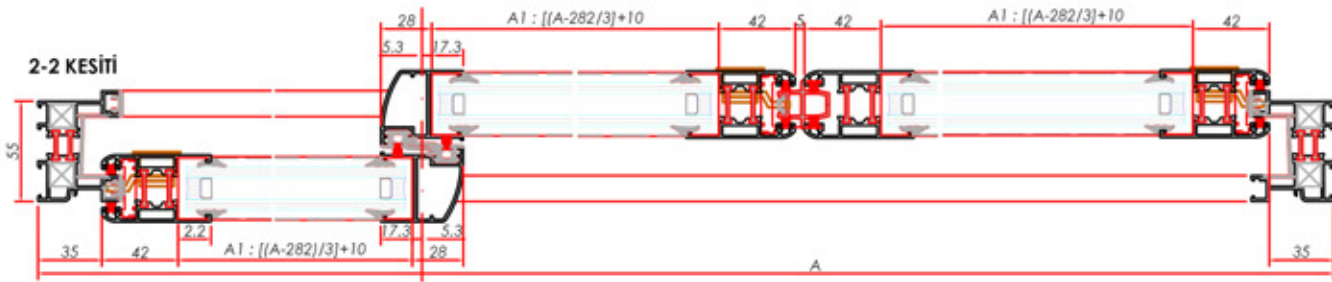
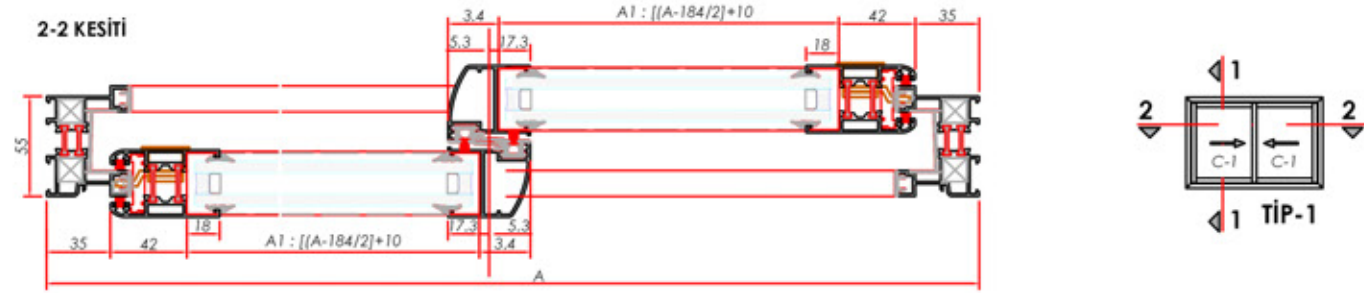

**AS55 TV 04 CUT AND GLASS SIZE TABLE**  
AS55 TV 04 KESİM VE CAM ÖLÇÜ TABLOSU

	AS55 TV 04	AS55 TV 02 AS55 TV 01	Glass Size Cam Ölçüsü		AS55 TV 03	Glass Size Cam Ölçüsü	
			W: Genişlik / Width H: Yükseklik / Height	W: Genişlik / Width H: Yükseklik / Height			
<b>TIP-1</b>	A1	$[(A-184)/2]+10$	C-1	W: $(A-184)/2$ H: B-188	$[(A-224)/2]+10$	C-1	W: $(A-224)/2$ H: B-188
<b>TIP-2</b>	A1	$[(A-282)/3]+10$	C-2	W: $(A-282)/3$ H: B-188	$[(A-362)/3]+10$	C-2	W: $(A-362)/3$ H: B-188
<b>TIP-3</b>	A1	$[(A-303)/4]+10$	C-3	W: $(A-303)/4$ H: B-188	$[(A-383)/4]+10$	C-3	W: $(A-383)/4$ H: B-188
<b>TIP-4</b>	A1	$[(A-345)/6]+10$	C-4	W: $(A-345)/6$ H: B-188	$[(A-425)/6]+10$	C-4	W: $(A-425)/6$ H: B-188



**ALCAS®**

**> GENERAL PROFILES & ACCESSORIES**  
**GENEL PROFİLLER VE AKSESUARLAR**

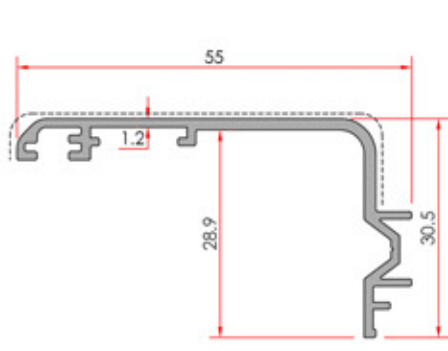

**Window Sill**  
Pervaz Profili

System Code	Profile No	Weight kg/m
1443	1443	0.392

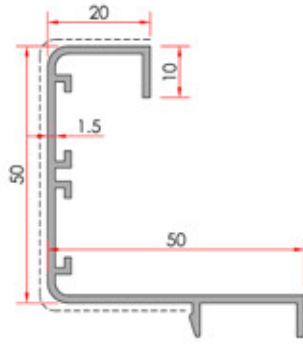

**Sill Profile**  
Pervaz Profili

System Code	Profile No	Weight kg/m
AW50 A 11	1237	0.643

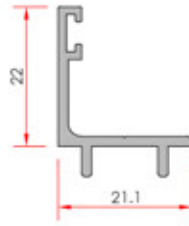

**Corner Cleat**  
İlave Kulak

System Code	Profile No	Weight kg/m
AWD60 A 05	1610	0.244

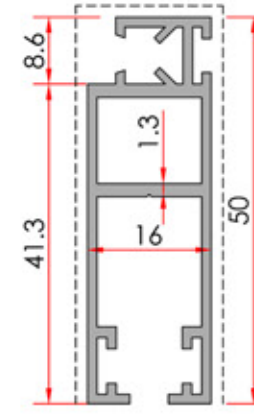

**Mosquito Netting**  
Sineklik Profili

System Code	Profile No	Weight kg/m
ASSO A 02	1409	0.555

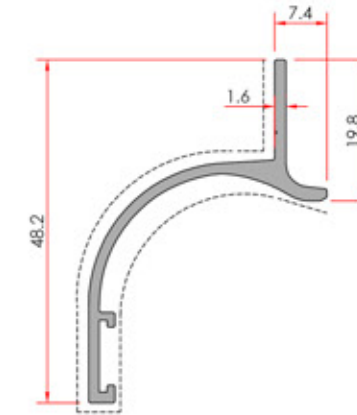

**Drainage**  
Damlalık Profili

System Code	Profile No	Weight kg/m
ASSO A 05	1426	0.363

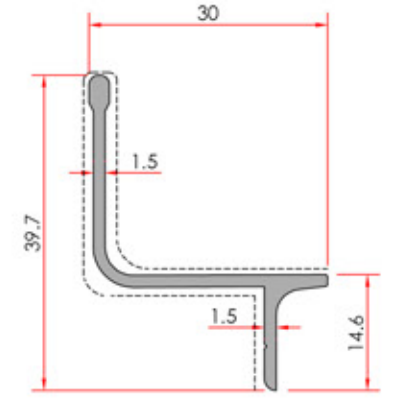

**Mosquito Netting Rail**  
Sineklik Rayı

System Code	Profile No	Weight kg/m
ASSO A 03	1427	0.295

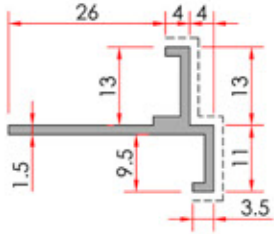

**Sill "T" Profile**  
Pervaz "T" Profili

System Code	Profile No	Weight kg/m
2147	2147	0.274

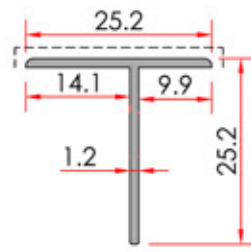

**Sill "T" Profile**  
Pervaz "T" Profili

System Code	Profile No	Weight kg/m
1874	1874	0.161

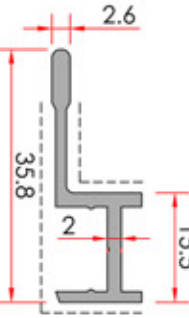

**Swapper Rail Profile**  
Sineklik Profili

System Code	Profile No	Weight kg/m
AKS129 A 07	1465	0.294

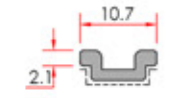

**Lock Stem Profile**  
Kilit Tij Profili

System Code	Profile No	Weight kg/m
ASSO A 08	1438	0.066

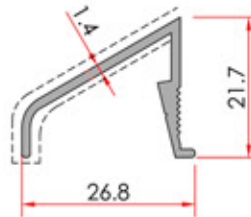

**Drainage**  
Damlalık Profili

System Code	Profile No	Weight kg/m
AW50 A 09	1321	0.234

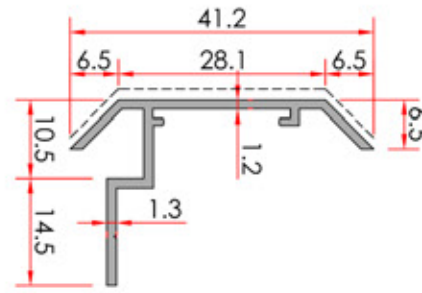

**Sill Profile**  
Pervaz Profili

System Code	Profile No	Weight kg/m
AW50 A 13	1458	0.268

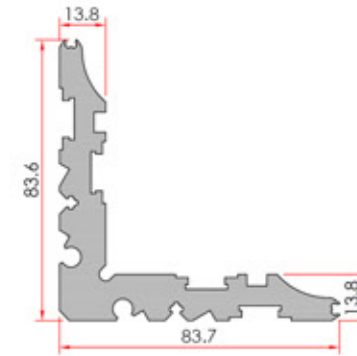

**Corner Wedge**  
Köşe Takozu

System Code	Profile No	Weight kg/m
1328	1328	4.110

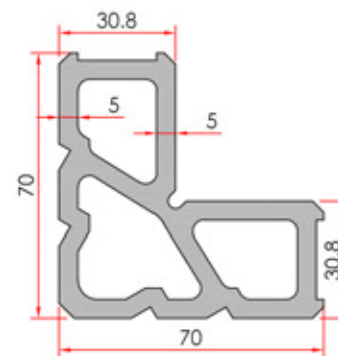

**Corner Wedge**  
Köşe Takozu

System Code	Profile No	Weight kg/m
1329	1329	4.388

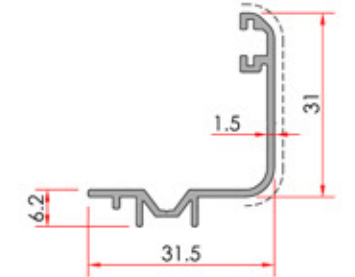

**Sill Profile**  
Pervaz Profili

System Code	Profile No	Weight kg/m
ASSO A 06	1428	0.286



**Sill Profile**  
Pervaz Profili

System Code	Profile No	Weight kg/m
AW50 A 14	4288	0.860

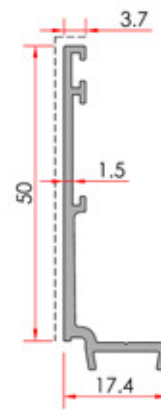

**Sill Profile**  
Pervaz Profili

System Code	Profile No	Weight kg/m
AW50 A 12	1359	0.363

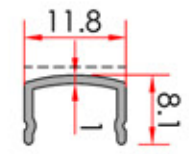

**Hand Rails Cover Profile - Köşe Takozu**

System Code	Profile No	Weight kg/m
1508	1508	0.067

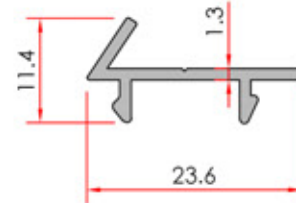

**Corner Cleat**  
İlave Kulak

System Code	Profile No	Weight kg/m
ASSO A 01	1318	0.143

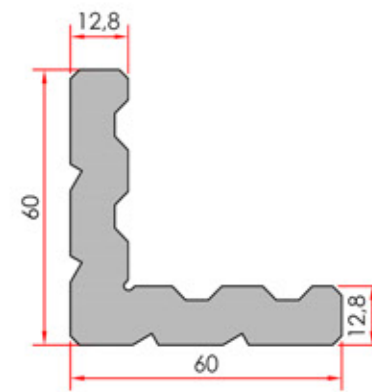

**Corner Cleat**  
Köşe Takozu

System Code	Profile No	Weight kg/m
1422	1422	3.451

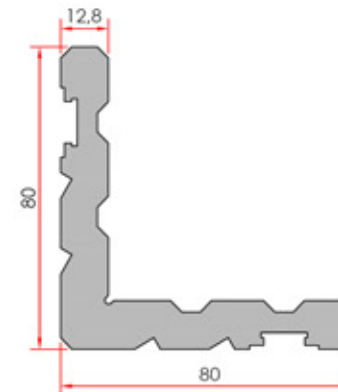

**Corner Cleat**  
Köşe Takozu



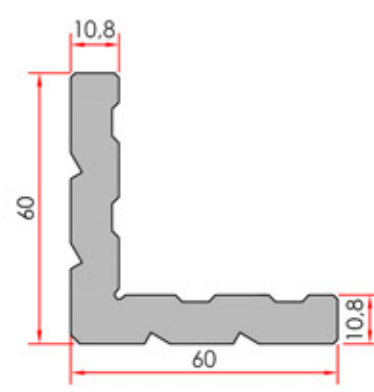

System Code	Profile No	Weight kg/m
1436	1436	4.481







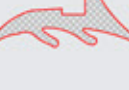



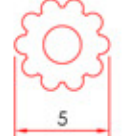





**Corner Cleat**  
Köşe Takozu





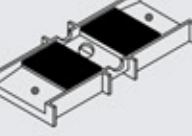
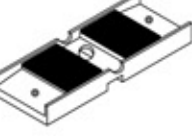
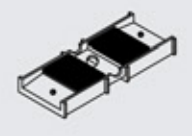

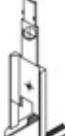
System Code	Profile No	Weight kg/m
1034	1034	3.056



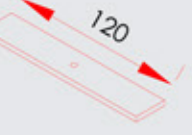
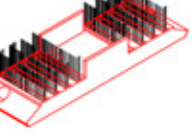

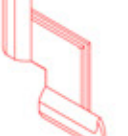

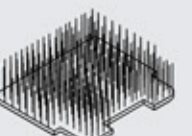



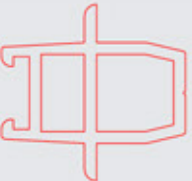

CODE / KOD	ACCESSORIES / AKSESUAR	DESCRIPTION / AÇIKLAMA
01-2002		<b>Gasket</b> İç Cam Fıtlı <b>Material</b> Malzeme:EPDM <b>Weight</b> Ağırlık:55 gr/m <b>Packing</b> Ambalaj:272 m - 15 kg /Koli
01-2005		<b>Gasket</b> 5 mm İç Cam Fıtlı <b>Material</b> Malzeme:EPDM <b>Weight</b> Ağırlık:63 gr/m <b>Packing</b> Ambalaj:235 m - 15 kg /Koli
01-2012		<b>Gasket</b> Dış Cam Fıtlı <b>Material</b> Malzeme:EPDM <b>Weight</b> Ağırlık:70 gr/m <b>Packing</b> Ambalaj:214 m - 15 kg /Koli
01-2013		<b>Gasket</b> 3 mm İç Cam Fıtlı <b>Material</b> Malzeme:EPDM <b>Weight</b> Ağırlık:50 gr/m <b>Packing</b> Ambalaj:300 m - 15 kg /Koli
01-2023		<b>Gasket</b> 3 mm Dış Cam Fıtlı <b>Material</b> Malzeme:EPDM <b>Weight</b> Ağırlık:40 gr/m <b>Packing</b> Ambalaj:375 m - 15 kg /Koli
01-2027		<b>Gasket</b> 5.5 mm İç Cam Fıtlı <b>Material</b> Malzeme:EPDM <b>Weight</b> Ağırlık:65 gr/m <b>Packing</b> Ambalaj:230 m - 15 kg /Koli
01-2151		<b>Clamp Gasket</b> Kenet Fıtlı <b>Material</b> Malzeme:EPDM <b>Weight</b> Ağırlık:245 gr/m <b>Packing</b> Ambalaj:60 m - 15 kg /Koli
01-2053		<b>Vent Top &amp; Bottom Gasket</b> Kanat Üst ve Alt Bini Fıtlı <b>Material</b> Malzeme:EPDM <b>Weight</b> Ağırlık:35 gr/m <b>Packing</b> Ambalaj:425 m - 15 kg /Koli
01-2054		<b>Clamp Kenet</b> <b>Material</b> Malzeme:EPDM
01-2055		<b>Stoper</b> Stoper <b>Material</b> Malzeme:EPDM





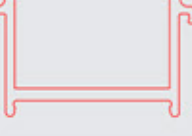

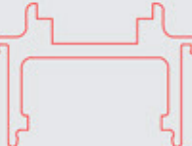
CODE / KOD	ACCESSORIES / AKSESUAR	DESCRIPTION / AÇIKLAMA
01-2056		<b>Mosquito Netting Gasket</b> Sineklik Fıtlı <b>Material</b> Malzeme:EPDM
01-2057		<b>24 mm Glazing Gasket</b> 24 mm Cam Fıtlı <b>Material</b> Malzeme:EPDM
01-2063		<b>Vent Side Gasket</b> Kanat Yan Bini Fıtlı <b>Material</b> Malzeme:EPDM <b>Weight</b> Ağırlık:44 gr/m <b>Packing</b> Ambalaj:335 m - 15 kg /Koli
01-2064		<b>Insulating Gasket</b> Yalıtım Fıtlı <b>Material</b> Malzeme:EPDM <b>Weight</b> Ağırlık:107 gr/m <b>Packing</b> Ambalaj:140 m - 15 kg /Koli
03-2006		
03-2007		<b>Glazing Cleat PVC</b> Cam Çıtası PVC Kitleme <b>Pieces / Adet</b>
03-2010 03-2011 03-2012		<b>12 mm Mounting Cap</b> 12 mm Montaj Tapası <b>Pieces / Adet</b>
03-3000		<b>Adaptor PVC</b> Adaptör PVC <b>Pieces / Adet</b>
03-3001		<b>Adaptor PVC</b> Adaptör PVC <b>Pieces / Adet</b>





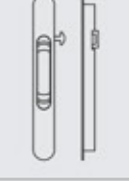
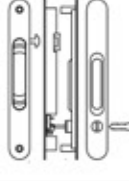
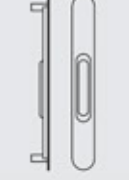

CODE / KOD	ACCESSORIES / AKSESUAR	DESCRIPTION / AÇIKLAMA
03-3002		<b>Rail PVC</b> Ray Üst Plastiği <b>Pieces / Adet</b>
03-3003		<b>Rail PVC</b> Ray Alt Plastiği <b>Pieces / Adet</b>
03-3010		<b>Rail PVC</b> Ray Plastiği <b>Pieces / Adet</b>
03-3011		<b>Rail PVC</b> Ray Plastiği <b>Pieces / Adet</b>
03-3012		<b>Rail PVC</b> Ray Plastiği <b>Pieces / Adet</b>
03-3020		<b>Adapter PVC</b> Adaptör Üst Plastiği <b>Pieces / Adet</b>
03-3021		<b>Adapter PVC</b> Adaptör Alt Plastiği <b>Pieces / Adet</b>
03-3022		<b>Adapter PVC</b> Adaptör Plastiği <b>Pieces / Adet</b>
03-3023		<b>Rail PVC</b> Ray Plastiği <b>Pieces / Adet</b>



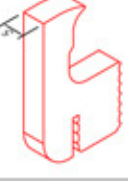
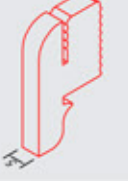
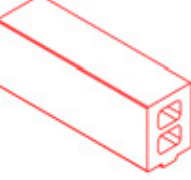

CODE / KOD	ACCESSORIES / AKSESUAR	DESCRIPTION / AÇIKLAMA
03-3030		<b>Fixed Vent Wedge</b> Sabit Kanat Takozu <b>Pieces / Adet</b>
03-3031		<b>PVC Rail Cap</b> Sabit Kanat Takozu <b>Pieces / Adet</b>
03-3100		<b>Insulation Adapter PVC</b> Yalıtım Adaptörü PVC <b>Pieces / Adet</b>
03-3101		<b>PVC Corner Climp</b> PVC Köşe Gönye <b>Pieces / Adet</b>
03-3102		<b>PVC Corner Climp</b> PVC Köşe Gönye <b>Pieces / Adet</b>
03-3103		<b>Vent Bottom Cap</b> Kanat Alt Kapak <b>Pieces / Adet</b>
03-3104		<b>Vent Top Cap</b> Kanat Üst Kapak <b>Pieces / Adet</b>
03-3105		<b>Adapter Bottom &amp; Top Brush</b> Adaptör Alt ve Üst Fırça <b>Pieces / Adet</b>
03-3112		<b>Insulation Adapter PVC</b> Yalıtım Adaptörü PVC <b>Pieces / Adet</b>

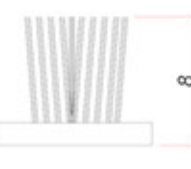

CODE / KOD	ACCESSORIES / AKSESUAR	DESCRIPTION / AÇIKLAMA
04-3000		<b>Meeting PVC Adaptor</b> Alın Birleştirme Adaptörü <b>Pieces / MT</b>
04-3001		<b>PVC Insulation</b> PVC Yalıtım Ambalaj:3 m Pieces / Adet
04-3002		<b>Clamp PVC</b> Kenet PVC Ambalaj:3 m Pieces / Adet
04-3003		<b>Vent Adapter PVC</b> Kanat Toplama Adaptör Plastiği <b>Pieces / Adet</b>
04-3004		<b>Clamp PVC</b> Kenet PVC Ambalaj:3 m Pieces / Adet
04-3500		<b>AKS129 Frame Insulation PVC</b> AKS129 Kasa Yalıtım Plastiği Ambalaj:3 m Pieces / Adet
04-3501		<b>Gear Supply PVC</b> İspanyolet Besleme Plastiği Ambalaj:3 m Pieces / Adet
04-3502		<b>Mounting Lama Insulation PVC</b> Montajı Laması Yalıtım Plastiği Packing Ambalaj:3 m Pieces / Adet
04-3503		<b>PVC Gear Set</b> PVC İspanyolet Yuvası <b>Packing</b> Ambalaj:3 m Pieces / Adet
05-1004		<b>Lock Counterpart</b> Havuz Kilit Karşılığı <b>Pieces / Adet</b>

CODE / KOD	ACCESSORIES / AKSESUAR	DESCRIPTION / AÇIKLAMA
09-1520 09-1521 09-1522 09-1523 09-1524		<b>Axial Gear Handle</b> Eksenel İspanyolet Kol (Maçalı) <b>Pieces / Adet</b>
09-1550 09-1551 09-1552 09-1553 09-1554		<b>Axial Parallel Slide &amp; Tilt Handle</b> Eksenel Paralel Çek-sür Kolu <b>Anodized / Ekoksal</b> <b>White / Beyaz</b> <b>Brown / Kahverengi</b> <b>Raw / Ham</b> <b>Special / Özel Renk</b>
09-1900 09-1901 09-1902		<b>Lock</b> Havuzlu Kilit <b>Pieces / Adet</b>
09-1910 09-1911 09-1912		<b>Lock</b> Anahtarlı Havuzlu Kilit <b>Pieces / Adet</b>
09-1915 09-1916 09-1917		<b>Lock Handle</b> Havuzlu Tutamak <b>Pieces / Adet</b>
09-2618		<b>18.2 mm Corner Miter</b> 18.2 mm Köşe Gönye (Onbaşı) <b>Corner Miter</b> Köşe Gönye (Onbaşı) <b>Pieces / Adet</b>
09-2750		<b>Adjustable Double Bearing</b> Ayarlı Çiftli Rulman <b>Pieces / Adet</b>
09-2751		<b>Insect Screen</b> Sineklik Rulmanı <b>Pieces / Adet</b>
09-2752		<b>Delrin Bearing</b> Delrin Rulmanı <b>Pieces / Adet</b>

CODE / KOD	ACCESSORIES / AKSESUAR	DESCRIPTION / AÇIKLAMA
09-2800		<b>Steel Rail</b> Çelik Ray <b>Pieces / MT</b>
09-2801		<b>Aluminium Rail</b> Alüminyum Ray <b>Pieces / MT</b>
09-2805		<b>Double Vent Slide Top Stop</b> Çift Kanat Sürme Stop Üst <b>Pieces / Adet</b>
09-2806		<b>Double Vent Slide Bottom Stop</b> Çift Kanat Sürme Stop Alt <b>Pieces / Adet</b>
09-2807		<b>AKS129 Fixing Wedge</b> AKS129 Sabitleme Takoğu <b>Pieces / Adet</b>
09-2820		<b>Espagnolette Locking Plates</b> Mantar Başlı İspanyolet Karşılığı <b>Pieces / Adet</b>
09-2865		<b>Gasket</b> Kil Fitol <b>Pieces / MT</b>
09-2870		<b>Gasket</b> Kil Fitol <b>Pieces / MT</b>
09-2880		<b>Brush Gasket</b> Kil Fitol <b>Pieces / MT</b>

CODE / KOD	ACCESSORIES / AKSESUAR	DESCRIPTION / AÇIKLAMA
09-5304		<b>Sliding Stopper</b> Sürme Kanat Durdurucu <b>Pieces / Adet</b>
09-5305		<b>Without Barrel Handle</b> Baresiz Kol <b>Pieces / Adet</b>
09-5306		<b>Single Side Barrel Handle</b> Tek Taraflı Barrel Kol <b>Pieces / Adet</b>
09-5307		<b>Double Side Barrel Handle</b> Çift Taraflı Barrel Kol <b>Pieces / Adet</b>
09-5308		<b>Gear Sliding Counterpart</b> İspanyolet Sürme Karşılığı <b>Pieces / Adet</b>

Lift & Slide 150 kg - Kaldır Sür 150 kg			
Gear Height - İspanyolet Yükseklik			
750-1450 mm	1451-1950 mm	1951-2200 mm	2201-3300 mm
09-5300	09-5301	09-5302	09-5303
Lift & Slide 200 kg - Kaldır Sür 200 kg			
Gear Height - İspanyolet Yükseklik			
750-1450 mm	1451-1950 mm	1951-2200 mm	2201-3300 mm
09-5310	09-5311	09-5312	09-5313

Gear - Mantar Pimli Sürme İspanyolet (Zamak Gövde)	
L	Code / Kodu
600	09-5320
800	09-5321
1000	09-5322
1200	09-5323
1400	09-5324
1600	09-5325
1800	09-5326
2000	09-5327



**ISO 9001 SERTİFİKASI**



**QUALICOAT SERTİFİKASI**



**QUALANOD SERTİFİKASI**



**IATF 16949 SERTİFİKASI**



**TSE HASSAS PROFİLLER BELGESİ**



**TSE YÜZEY İŞLEM BELGESİ**



**TSE İMALATI YETERLİLİK BELGESİ**



**ISO 14001**



**OHSAS 18001 BELGESİ**



**FABRİKA ÜRETİM UYGUNLUK**



**CE BELGESİ**



**GOST-R SERTİFİKASI**





# ALCAS®

ALUMINIUM PROFILE SYSTEMS

444 36 44

alcas@alcas.com.tr

www.alcas.com.tr

Kaya Milenium Plaza Kat 7 No:139 Beykent / İstanbul +90212 871 1771

Velimeşe Islah OSB 129.Sok.11/1 Ergene / Tekirdağ +90282 6745175

alcasmetal

alcasaluminyum

alcasmetal

alcasmetal

alcasmetal



All designs, profiles and accessories listed in this catalog are © copyrighted and ® registered products. May not be copied, altered or posted online by any means. Bu katalogta yer alan tasarımlar, profiller ve aksesuarlar tescilli ve patentli ürünlerimizdir. Hiçbir şekilde kopyalanamaz ve taklit edilemez.

Dünyanın yeni profil sistemi

